



3-DNS[®] Administrator Guide

version 4.5

Product Version

This manual applies to version 4.5 of 3-DNS® Controller.

Legal Notices

Copyright

Information in this document is subject to change without notice.

© 2002 Dell Computer Corporation. All rights reserved.

Reproduction in any manner whatsoever without the written permission of Dell Computer Corporation is strictly forbidden.

Trademarks used in this text: *Dell* and *PowerEdge* are trademarks of Dell Computer Corporation.

Other trademarks and trade names may be used in this document to refer to either the entities claiming the marks and names or their products. Dell Computer Corporation disclaims any proprietary interest in trademarks and trade names other than its own.

Copyright 1998-2002, F5 Networks, Inc. All rights reserved.

F5 Networks, Inc. (F5) believes the information it furnishes to be accurate and reliable. However, F5 assumes no responsibility for the use of this information, nor any infringement of patents or other rights of third parties which may result from its use. No license is granted by implication or otherwise under any patent, copyright, or other intellectual property right of F5 except as specifically described by applicable iControl user licenses. F5 reserves the right to change specifications at any time without notice.

Trademarks

F5, F5 Networks, the F5 logo, BIG-IP, 3-DNS, iControl, GLOBAL-SITE, SEE-IT, EDGE-FX, FireGuard, Internet Control Architecture, and IP Application Switch are registered trademarks or trademarks of F5 Networks, Inc. in the U.S. and certain other countries. All other product and company names are registered trademarks or trademarks of their respective holders. F5 trademarks may not be used in connection with any product or service except as permitted in writing by F5.

Export Regulation Notice

This product may include cryptographic software. Under the Export Administration Act, the United States government may consider it a criminal offense to export this product from the United States.

Export Warning

This is a Class A product. In a domestic environment this product may cause radio interference in which case the user may be required to take adequate measures.

FCC Compliance

This equipment generates, uses, and may emit radio frequency energy. The equipment has been type tested and found to comply with the limits for a Class A digital device pursuant to Part 15 of FCC rules, which are designed to provide reasonable protection against such radio frequency interference.

Operation of this equipment in a residential area may cause interference, in which case the user at his own expense will be required to take whatever measures may be required to correct the interference.

Any modifications to this device, unless expressly approved by the manufacturer, can void the user's authority to operate this equipment under part 15 of the FCC rules.

Canadian Regulatory Compliance

This class A digital apparatus complies with Canadian I CES-003.

Standards Compliance

The product conforms to ANSI/UL Std 1950 and Certified to CAN/CSA Std. C22.2 No. 950.

Acknowledgments

This product includes software developed by the University of California, Berkeley and its contributors.

This product includes software developed by the Computer Systems Engineering Group at the Lawrence Berkeley Laboratory.

This product includes software developed by the NetBSD Foundation, Inc. and its contributors.

This product includes software developed by Christopher G. Demetriou for the NetBSD Project.

This product includes software developed by Adam Glass.

This product includes software developed by Christian E. Hopps.

This product includes software developed by Dean Huxley.

This product includes software developed by John Kohl.

This product includes software developed by Paul Kranenburg.

This product includes software developed by Terrence R. Lambert.

This product includes software developed by Philip A. Nelson.

This product includes software developed by Herb Peyerl.

This product includes software developed by Jochen Pohl for the NetBSD Project.

This product includes software developed by Chris Provenzano.

This product includes software developed by Theo de Raadt.

This product includes software developed by David Muir Sharnoff.

This product includes software developed by SigmaSoft, Th. Lockert.

This product includes software developed for the NetBSD Project by Jason R. Thorpe.

This product includes software developed by Jason R. Thorpe for And Communications, <http://www.and.com>.

This product includes software developed for the NetBSD Project by Frank Van der Linden.

This product includes software developed for the NetBSD Project by John M. Vinopal.

This product includes software developed by Christos Zoulas.

This product includes software developed by Charles Hannum.

This product includes software developed by Charles Hannum, by the University of Vermont and Stage Agricultural College and Garrett A. Wollman, by William F. Jolitz, and by the University of California, Berkeley, Lawrence Berkeley Laboratory, and its contributors.

This product includes software developed by the University of Vermont and State Agricultural College and Garrett A. Wollman.

In the following statement, "This software" refers to the Mitsumi CD-ROM driver: This software was developed by Holger Veit and Brian Moore for use with "386BSD" and similar operating systems.

"Similar operating systems" includes mainly non-profit oriented systems for research and education, including but not restricted to "NetBSD," "FreeBSD," "Mach" (by CMU).

In the following statement, "This software" refers to the parallel port driver: This software is a component of "386BSD" developed by William F. Jolitz, TeleMuse.

This product includes software developed by the Apache Group for use in the Apache HTTP server project (<http://www.apache.org/>).

This product includes software developed by Darren Reed. (© 1993-1998 by Darren Reed).

This product includes software licensed from Richard H. Porter under the GNU Library General Public License (© 1998, Red Hat Software), www.gnu.org/copyleft/lgpl.html.

This product includes the standard version of Perl software licensed under the Perl Artistic License (© 1997, 1998 Tom Christiansen and Nathan Torkington). All rights reserved. You may find the most current standard version of Perl at <http://www.perl.com>.

This product includes software developed by Eric Young.

Rsync was written by Andrew Tridgell and Paul Mackerras, and is available under the Gnu Public License.

This product includes Malloc library software developed by Mark Moraes. (© 1988, 1989, 1993, University of Toronto).

This product includes open SSL software developed by Eric Young (eay@cryptsoft.com), (© 1995-1998).

This product includes open SSH software developed by Tatu Ylonen (ylo@cs.hut.fi), Espoo, Finland (© 1995).

This product includes open SSH software developed by Niels Provos (© 1999).

This product includes SSH software developed by Mindbriht Technology AB, Stockholm, Sweden, www.mindbriht.se, info@mindbriht.se (© 1998-1999).

This product includes free SSL software developed by Object Oriented Concepts, Inc., St. John's, NF, Canada (© 2000).

This product includes software developed by Object Oriented Concepts, Inc., Billerica, MA, USA (© 2000).

This product includes RRDtool software developed by Tobi Oetiker (<http://www.rrdtool.com/index.html>) and licensed under the GNU General Public License.



Table of Contents

1

Introduction

IMPORTANT HARDWARE INFORMATION	1-1
Getting started	1-1
Choosing a configuration tool	1-2
Browser support	1-3
Using the Administrator Kit	1-3
\Stylistic conventions	1-4
What is the 3-DNS Controller?	1-5
Internet protocol and network management support	1-6
Security features	1-6
Configuration scalability	1-6
System synchronization options	1-7
Configuring data collection for server status and network path data	1-7
Redundant system configurations	1-8
What's new in version 4.5	1-9
Automatic discovery	1-9
Easy system account and password creation	1-9
Enhanced synchronization	1-9
Expanded statistics	1-10
Multi-homing and firewall support	1-10
Security enhancements	1-10
Finding help and technical support resources	1-11

2

Planning the 3-DNS Configuration

Managing traffic on a global network	2-1
Understanding a basic 3-DNS configuration	2-1
Synchronizing configurations and broadcasting performance metrics	2-2
Using a 3-DNS Controller as a standard DNS server	2-3
Load balancing connections across the network	2-4
Working with 3-DNS Controllers and other products	2-4
Planning issues for the network setup	2-6
Configuring the base network	2-6
Defining data centers and servers	2-7
Planning a sync group	2-7
Setting up communications on a 3-DNS Controller	2-8
Choosing the 3-DNS mode	2-10
Running a 3-DNS Controller in node mode	2-10
Running a 3-DNS Controller in bridge mode or router mode	2-11
Planning issues for the load balancing configuration	2-12
Using advanced traffic control features	2-12

3

Using the Setup Utility

Creating the initial software configuration with the Setup utility	3-1
Connecting to the 3-DNS Controller for the first time	3-2
Running the utility from the console or serial terminal	3-2
Running the Setup utility remotely	3-2
Using the Setup utility for the first time	3-5
Keyboard type	3-5
Root password	3-5
Host name	3-6
Redundant system settings	3-6

Setting the interface media type	3-7
Configuring VLANs and IP addresses	3-7
Configuring a default gateway pool	3-8
Configuring remote web server access	3-8
Configuring remote administrative access	3-9
Setting support access	3-10
Setting the time zone	3-10
Configuring NTP support	3-10
Configuring the 3-DNS mode	3-11
Configuring user authentication	3-11
Configuring NameSurfer for zone file management	3-13
Running the Setup utility after creating the initial software configuration	3-14
Options available only through the Setup utility menu	3-15

4

Post-Setup Tasks

Introduction	4-1
Configuring the interfaces	4-2
Understanding the interface naming convention	4-2
Displaying status for interfaces	4-2
Setting the media type	4-3
Setting the duplex mode	4-3
Working with VLANs	4-4
Default VLAN configuration	4-4
Creating, renaming, and deleting VLANs	4-5
Configuring packet access to VLANs	4-7
Setting up security for VLANs	4-9
Setting fail-safe timeouts for VLANs	4-10
Setting the MAC masquerade address	4-11
Configuring a self IP address	4-12

5

Essential Configuration Tasks

Reviewing the configuration tasks	5-1
Setting up a basic configuration	5-2
Setting up a data center	5-3
Setting up servers	5-5
Defining 3-DNS Controllers	5-5
Defining BIG-IP systems	5-6
Defining a BIG-IP system with the 3-DNS module	5-7
Defining a router	5-8
Defining EDGE-FX systems	5-9
Defining host servers	5-10
Configuring host SNMP settings	5-12
Working with sync groups	5-13
Configuring sync groups	5-13
Setting the time tolerance value	5-14
Overview of auto-configuration	5-15
Configuring global variables	5-17

6

Configuring a Globally-Distributed Network

Understanding a globally-distributed network	6-1
Using Topology load balancing	6-2
Setting up a globally-distributed network configuration	6-2
Adding data centers to the globally-distributed network configuration	6-3
Adding 3-DNS Controllers to the globally-distributed network configuration	6-3
Adding BIG-IP systems to the globally-distributed network configuration	6-4
Adding wide IPs to the globally-distributed network configuration	6-5
Configuring topology records for the globally-distributed network configuration	6-6
Additional configuration settings and tools	6-7
Setting limits thresholds	6-7
Other resources	6-8

7

Configuring a Content Delivery Network

Introducing the content delivery network	7-1
Using the 3-DNS Controller in a CDN	7-1
Reviewing a sample CDN configuration	7-2
Deciding to use a CDN provider	7-4
Setting up a CDN provider configuration	7-5
Adding data centers	7-5
Adding 3-DNS Controllers	7-5
Adding load balancing servers	7-6

Table of Contents

Running the 3dns_add script	10-4
Verifying the configuration	10-4

Glossary

Index



1

Introduction

- IMPORTANT HARDWARE INFORMATION
- Getting started
- Using the Administrator Kit
- What is the 3-DNS Controller?
- What's new in version 4.5
- Finding help and technical support resources

IMPORTANT HARDWARE INFORMATION

References to hardware and upgrades contained in this document are specific to F5 Networks hardware products. For information concerning the initial deployment of your system, see the *Deployment Guide* that was shipped with your system. For in-depth Dell-specific hardware information, see the server documentation that is provided on the *Resource CD* and that shipped with your system if you ordered printed documentation.

References to hardware-specific features of the F5 Networks IP Application Switch, such as the spanning tree protocol and port mirroring, are not supported on Dell™ PowerEdge™ hardware.

Getting started

The *3-DNS Administrator Guide* is designed to help you quickly install and configure the 3-DNS® Controller to manage your wide-area network traffic and DNS. The Administrator Guide contains the following chapters:

- ◆ **Planning the 3-DNS Configuration**
This chapter describes the network and configuration planning you need to do before you install the 3-DNS Controller in your network.
- ◆ **Working with the Setup Utility**
This chapter describes the Setup utility and its functions. The Setup utility runs automatically the first time you turn on the 3-DNS Controller.
- ◆ **Post-Setup Tasks**
This chapter describes the base network, which includes the IP addresses, VLANs, and network interfaces on the 3-DNS Controller.
- ◆ **Essential Configuration Tasks**
This chapter describes the software configuration tasks you must complete, regardless of the type of wide-area traffic management you want to configure.
- ◆ **Configuring a Globally Distributed Network**
This chapter describes the tasks you complete to set up a globally distributed network.
- ◆ **Configuring a Content Delivery Network**
This chapter describes the tasks you complete to set up a network that includes a CDN provider.
- ◆ **Working with Quality of Service**
This chapter describes the components of the Quality of Service load balancing mode.

- ◆ **Working with Global Availability Load Balancing**

This chapter describes the components of the Global Availability load balancing mode.

- ◆ **Adding a 3-DNS Controller to an Existing Network**

This chapter describes the tasks you complete to configure an additional 3-DNS Controller in a network that already contains one or more 3-DNS Controllers.

Choosing a configuration tool

The 3-DNS Controller provides several web-based and command line administrative tools that make for easy setup and configuration. Use the following overview to help you decide when each utility is best used.

Setup utility

The Setup utility is a wizard that walks you through the initial system setup. The utility helps you quickly define basic system settings, such as a **root** password and the IP addresses for the interfaces that connect the 3-DNS Controller to the network. The Setup utility also helps you configure access to the 3-DNS web server, which hosts the web-based Configuration utility, as well as the NameSurfer™ application that you can use for DNS zone file management.

Configuration utility

The Configuration utility is a web-based application that you use to configure and monitor the 3-DNS Controller. Using the Configuration utility, you can define the load balancing configuration along with the network setup, including data centers, sync groups, and servers used for load balancing and path probing. In addition, you can configure advanced features such as topology settings and SNMP agents. The Configuration utility also monitors network traffic, current connections, load balancing statistics, performance metrics, and the operating system itself. The home screen of the Configuration utility provides convenient access to downloads such as the SNMP MIB, and documentation for third-party applications such as NameSurfer.

NameSurfer application

The NameSurfer application is a third-party application that automatically configures DNS zone files associated with domains handled by the 3-DNS Controller. You can use NameSurfer to configure and maintain additional DNS zone files on a 3-DNS Controller that runs as a primary DNS server. The Configuration utility provides direct access to the NameSurfer application, as well as the corresponding documentation for the application.

Please note that your license allows you to manage a maximum of 100 IP addresses in the NameSurfer application. For more information, refer to the end-user license agreement included in your product shipment.

3-DNS Maintenance menu

The 3-DNS Maintenance menu is a command line utility that runs scripts which assist you in configuration and administrative tasks, such as installing the latest version of the **big3d** agent on all your systems, or setting up encrypted communications in the network. You can use the 3-DNS Maintenance menu from a console connection, from a remote shell connection, or from the MindTerm SSH Client in the Configuration utility.

Browser support

The Configuration utility, which provides web-based access to the 3-DNS configuration and features, supports the following browser versions:

- Netscape Navigator 4.7
- Microsoft Internet Explorer, version 5.0 or 5.5

Using the Administrator Kit

The 3-DNS Administrator Kit provides simple steps for quick, basic configuration, and also provides detailed information about more advanced features and tools, such as the **3dnsmaint** command line utility. The following printed documentation is included with the 3-DNS unit.

◆ **Configuration Worksheet**

This worksheet provides you with a place to plan the basic configuration for the 3-DNS Controller.

The following guides are available in PDF format from the CD-ROM provided with the 3-DNS Controller. These guides are also available from the home screen of the Configuration utility.

◆ **Platform Guide**

This guide includes information about the physical 3-DNS unit. It also contains important environmental warnings.

◆ **3-DNS Administrator Guide**

The *3-DNS Administrator Guide* provides examples of common wide-area load balancing solutions supported by the 3-DNS Controller. For example, you can find everything from a basic DNS request load balancing solution to a more advanced content acceleration load balancing solution. This guide also covers general network administration issues, such as installing the hardware and setting up the networking configuration.

◆ **3-DNS Reference Guide**

The *3-DNS Reference Guide* provides basic descriptions of individual 3-DNS objects, such as wide IPs, pools, virtual servers, load balancing modes, the **big3d** agent, resource records, and production rules. It also provides syntax information for **3dnsmaint** commands, configuration utilities, the **wideip.conf** file, and system utilities.

Stylistic conventions

To help you easily identify and understand certain types of information, this documentation uses the following stylistic conventions.

All examples in this documentation use only non-routable IP addresses. When you set up the solutions we describe, you must use IP addresses suitable to your own network in place of our sample IP addresses.

Identifying new terms

When we first define a new term, the term is shown in bold italic text. For example, a ***wide IP*** is a mapping of a fully-qualified domain name to a set of virtual servers that host the domain's content.

Identifying references to products

We refer to all products in the BIG-IP product family as the BIG-IP system. We refer to the 3-DNS Controller and the 3-DNS module as the 3-DNS Controller. If specific configuration information relates to a specific platform, we note the platform.

Identifying references to objects, names, and commands

We apply bold text to a variety of items to help you easily pick them out of a block of text. These items include web addresses, IP addresses, utility names, and portions of commands, such as variables and keywords. For example, the **nslookup** command requires that you include at least one **<ip_address>** variable.

Identifying references to other documents

We use italic text to denote a reference to another document. In references where we provide the name of a book as well as a specific chapter or section in the book, we show the book name in bold, italic text, and the chapter/section name in italic text to help quickly differentiate the two. For example, you can find information about topology in the ***3-DNS Reference Guide***, Chapter 3, *Topology*.

Identifying command syntax

We show actual, complete commands in bold Courier text. Note that we do not include the corresponding screen prompt, unless the command is shown in a figure that depicts an entire command line screen. For example, the following command sets the 3-DNS Controller load balancing mode to Round Robin:

```
lb_mode rr
```

Table 1.1 explains additional special conventions used in command line syntax.

Item in text	Description
\	Continue to the next line without typing a line break.
< >	You enter text for the enclosed item. For example, if the command has < your name >, type in your name.
	Separates parts of a command.
[]	Syntax inside the brackets is optional.
...	Indicates that you can type a series of items.

Table 1.1 *Command line conventions used in this manual*

What is the 3-DNS Controller?

A 3-DNS Controller is a network appliance that monitors the availability and performance of global resources, and uses that information to manage network traffic patterns. The 3-DNS Controller uses load balancing algorithms, topology-based routing, and production rules to control and distribute traffic according to specific policies. The system is highly configurable, and its web-based and command line configuration utilities allow for easy system setup and monitoring.

The 3-DNS Controller provides a variety of features that meet special needs. For example, with this product you can:

- Configure a content delivery network with a CDN provider
- Guarantee multiple port availability for e-commerce sites
- Ensure wide-area persistence by maintaining a mapping between an local DNS server and a virtual server in a wide IP pool
- Direct local clients to local servers for globally-distributed sites using Topology load balancing
- Change the load balancing configuration according to current traffic patterns or time of day
- Customize load balancing modes

- Set up load balancing among BIG-IP systems, EDGE-FX Caches, and other load-balancing hosts
- Monitor real-time network conditions

Internet protocol and network management support

The 3-DNS Controller supports both the standard DNS protocol and the 3-DNS iQuery protocol (a protocol used for collecting dynamic load balancing information). The 3-DNS Controller also supports administrative protocols, such as Simple Network Management Protocol (SNMP), and Simple Mail Transfer Protocol (SMTP) (outbound only), for performance monitoring and notification of system events. For administrative purposes, you can use SSH, RSH, Telnet, and FTP. The Configuration utility supports HTTPS, for secure web browser connections using SSL, as well as standard HTTP connections.

The proprietary 3-DNS SNMP agent allows you to monitor status and current traffic flow using popular network management tools. The 3-DNS SNMP agent provides detailed data such as current connections being handled by each virtual server.

Security features

The 3-DNS Controller offers a variety of security features that can help prevent hostile attacks on your site or equipment.

◆ **Secure administrative connections**

The 3-DNS Controller supports Secure Shell (SSH) administrative connections using the Mindterm SSH Client, for browser-based remote administration, and SSH for remote administration from the command line. The 3-DNS web server, which hosts the web-based Configuration utility, supports SSL connections as well as user authentication.

◆ **Secure iQuery communications**

Crypto versions of the 3-DNS Controller also support Blowfish encryption for iQuery communications between the 3-DNS Controller and other systems running the **big3d** agent.

◆ **TCP wrappers**

TCP wrappers provide an extra layer of security for network connections.

Configuration scalability

The 3-DNS Controller is a highly scalable and versatile solution. You can configure the 3-DNS Controller to manage up to several hundred domain names, including full support of domain name aliases. The 3-DNS

Controller supports a variety of media options, including Fast Ethernet, and Gigabit Ethernet; the 3-DNS Controller also supports multiple network interface cards that can provide redundant or alternate paths to the network.

◆ **Note**

If you use NameSurfer to manage your DNS zone files, you can configure only up to 100 IP addresses and domain names.

System synchronization options

The 3-DNS Controller sync group feature allows you to automatically synchronize configurations from one 3-DNS Controller to any other 3-DNS Controller in the network, simplifying administrative management. The synchronization feature offers a high degree of administrative control. For example, you can set the 3-DNS Controller to synchronize a specific configuration file set, and you can also set which 3-DNS Controllers in the network receive the synchronized information and which ones do not.

Configuring data collection for server status and network path data

The 3-DNS platform includes the **big3d** agent, which is an integral part of 3-DNS load balancing. The **big3d** agent continually monitors the availability of the servers that the 3-DNS Controller load balances. It also monitors the integrity of the network paths between the servers that host the domain, and the various local DNS servers that attempt to connect to the domain. The **big3d** agent runs on any of the following platforms: 3-DNS Controller, BIG-IP systems, EDGE-FX Cache, and GLOBAL-SITE Controller. Each **big3d** agent broadcasts its collected data to all of the 3-DNS Controllers in your network, ensuring that all 3-DNS Controllers work with the latest information.

The **big3d** agent offers a variety of configuration options that allow you to choose the data collection methods you want to use. For example, you can configure the **big3d** agent to track the number of router hops (intermediate system transitions) along a given network path, and you can also set the **big3d** agent to collect host server performance information using the SNMP protocol. For further details on the **big3d** agent, refer to the *3-DNS Reference Guide*, Chapter 5, *Probing and Metrics Collection*.

Redundant system configurations

A *redundant system* is essentially a pair of 3-DNS units, with one operating as the active unit that responds to DNS queries, and the other one operating as the standby unit. If the active unit fails, the standby unit takes over and begins to respond to DNS queries while the other 3-DNS unit restarts and becomes the standby unit.

The 3-DNS Controller actually supports two methods of checking the status of the peer system in a redundant system:

◆ **Hardware-based fail-over**

In a redundant system that has been set up with hardware-based fail-over, the two units in the system are connected to each other directly using a fail-over cable attached to the serial ports. The standby unit checks on the status of the active unit once every second using this serial link.

◆ **Network-based fail-over**

In a redundant system that has been set up with network-based fail-over, the two units in the system communicate with each other across an Ethernet network instead of going across a dedicated fail-over serial cable. The standby unit checks on the status of the active unit once every second using the Ethernet.

◆ **Note**

In a network-based fail-over configuration, the standby 3-DNS unit immediately takes over if the active unit fails. If a client has queried the failed 3-DNS unit, and not received an answer, it automatically re-issues the request (after 5 seconds) and the standby unit, functioning as the active unit, responds.

Monitoring the 3-DNS Controller and the network

The 3-DNS Controller includes sophisticated monitoring tools to help you monitor the 3-DNS Controller, the traffic it manages, and the Internet. The following monitoring tools are available on the 3-DNS Controller: the Statistics screens, the Internet Weather Map, and the Network Map. All of these tools are in the Configuration utility.

Comparing a 3-DNS Controller to a BIG-IP system

A 3-DNS Controller load balances traffic for a globally-distributed network, and a BIG-IP system load balances traffic for a local area network. While both systems provide load balancing, one of the significant differences between the BIG-IP system and the 3-DNS Controller is that the 3-DNS Controller responds to DNS requests issued by an LDNS on behalf of a client, while the BIG-IP system provides connection management between a client and a back-end server.

Once the 3-DNS Controller returns a DNS answer to an LDNS, the conversation between the LDNS and the 3-DNS Controller ends, and the client connects to the IP address returned by the 3-DNS Controller. Unlike the 3-DNS Controller, the BIG-IP system sits between the client and the content servers. It manages the client's entire conversation with the content server.

What's new in version 4.5

The 3-DNS Controller, version 4.5 offers the following major new features in addition to many other enhancements.

Automatic discovery

The 3-DNS Controller can now automatically collect and add the virtual server configuration information for any BIG-IP systems and host servers in the 3-DNS Controller configuration. The **Discovery** setting has three levels: **OFF**, **ON**, and **ON/NO DELETE**. For more information on auto-configuration and the **Discovery** setting, see *Overview of auto-configuration*, on page 5-16.

Easy system account and password creation

With this release, the 3-DNS Controller now offers one screen, in the web-based Setup utility, where you can set the passwords for the three system accounts: **root**, **admin**, and **support**. On this screen, you can also specify whether to allow command line access, web access, or both for the support account. You can view the **User Access** screen by opening the Setup utility from the home screen. For more information on user accounts and system accounts, see Chapter 6, *Administration and Monitoring*, in the 3-DNS Reference Guide.

Enhanced synchronization

The configuration synchronization process for the 3-DNS Controller has been updated and improved. The controller no longer relies on the **syncd** daemon for synchronization. Instead, synchronization occurs automatically, based on file timestamps, whenever you make any type of change to the configuration. The 3-DNS Controller also polls any Link Controllers that you have in your network, and synchronizes the link information across the sync group. Note that working with sync groups remains the same.

Expanded statistics

The statistics screens on the 3-DNS Controller have been enhanced and expanded. You can now view statistics for the following objects:

- The Detailed Wide IP Statistics screen, available from the Wide IP Statistics screen, now displays information about virtual servers in the context of the wide IP pools of which they are members.
- The Link Statistics screen displays information about any router links you have configured.
- The P95 Billing Estimate statistics screen displays graphs of your actual bandwidth usage compared to your purchased bandwidth if you have links configured, or your network has both 3-DNS Controllers and Link Controllers in it.
- The Internet Weather Map statistics screen now displays information for both the data centers and the links in your network.
- The Disabled Objects statistics screen now displays these additional objects: wide IPs, pools, and virtual servers.

For details on each of these screens, refer to the online help for that screen.

Multi-homing and firewall support

The 3-DNS Controller now supports multiple links to the Internet and network address translations for firewalls. You can designate one or more self IP addresses and translations for the controller itself, as well as for any BIG-IP systems, host servers, or routers that are configured as part of the controller's network. For information on working with the self IP addresses and network address translations, refer to the online help for the Self IP List, which is available from the toolbar for each server type.

Security enhancements

You can now use the Setup utility to configure a remote LDAP or RADIUS authentication server. With this feature, you no longer need to directly edit configuration files to set up your LDAP or RADIUS authentication server.

This release of the 3-DNS Controller also expands the number of user roles that you can assign to user accounts for the purpose of user authorization. In addition to the standard Full Read/Write, Partial Read/Write, and Read-Only access levels, you can now define which user interface an administrator uses to access the 3-DNS Controller (the Configuration utility, the command line interface, or the iControl interface). These user authorization roles are stored in the local LDAP database on the 3-DNS Controller, and are designed to operate in concert with centralized LDAP and RADIUS authentication.

For details on user authorization and managing user accounts, see *Managing user accounts*, in Chapter 6, *Administration and Monitoring*, in the **3-DNS Reference Guide**.

Finding help and technical support resources

You can find additional technical documentation about the 3-DNS Controller in the following locations:

◆ **Release notes**

Release notes for the 3-DNS Controller are available from the home screen of the Configuration utility. The release note contains the latest information for the current version, including a list of new features and enhancements, a list of fixes, and a list of known issues.

◆ **Online help for 3-DNS features**

You can find help online in three different locations:

- The Configuration utility home screen has PDF versions of the guides included in the Administrator Kit. 3-DNS software upgrades may replace the guides with updated versions as appropriate.
- The Configuration utility has online help for each screen. Click the **Help** button on the toolbar.
- Individual commands have online help, including command syntax and examples, in standard UNIX man page format. Type the command followed by **-h** or **-help**, and the 3-DNS Controller displays the syntax and usage associated with the command. You can also type **man <command>** to display the man page for the command.

◆ **Third-party documentation for software add-ons**

The Configuration utility contains online documentation for the third-party software included with the 3-DNS Controller, including the NameSurfer application.

◆ **Technical support through the World Wide Web**

The Dell Support website at support.dell.com provides the latest technical documentation.

◆ **Note**

All references to hardware platforms in this guide refer specifically to systems supplied by F5 Networks, Inc. If your hardware was supplied by another vendor and you have hardware-related questions, please refer to the documentation from that vendor.



2

Planning the 3-DNS Configuration

- Managing traffic on a global network
- Planning issues for the network setup
- Choosing the 3-DNS mode
- Planning issues for the load balancing configuration
- Using advanced traffic control features

Managing traffic on a global network

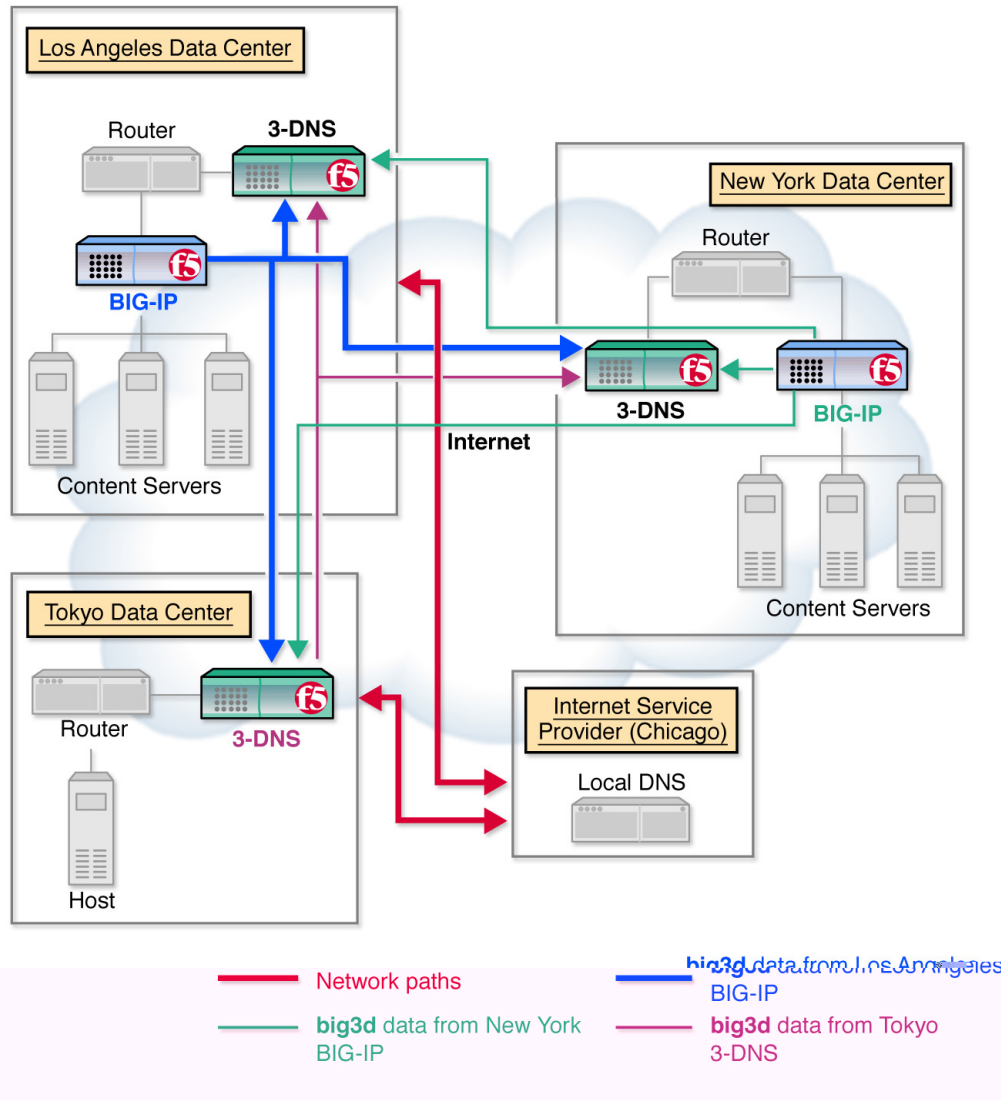

Figure 2.1 A sample network layout showing data paths

Synchronizing configurations and broadcasting performance metrics

3-DNS Controllers typically work in sync groups, where a group of controllers shares load balancing configuration settings. In a sync group, any system that has new configuration changes can broadcast the changes to any other system in the sync group, allowing for easy administrative maintenance. To distribute metrics data among the systems in a sync group, the principal 3-DNS Controller sends requests to the **big3d** agents in the network, asking them to collect specific performance and path data. Once

the **big3d** agents collect the data, they each broadcast the collected data to all systems in the network, again allowing for simple and reliable metrics distribution.

Using a 3-DNS Controller as a standard DNS server

When a client requests a DNS resolution for a domain name, an LDNS sends the request to one of the 3-DNS Controllers that is authoritative for the zone. The 3-DNS Controller first chooses the best available virtual server out of a pool to respond to the request, and then returns a DNS resource record to the requesting local DNS server. The LDNS server uses the answer for the period of time defined within the resource record. Once the answer expires, however, the LDNS server must request name resolution all over again to get a fresh answer.

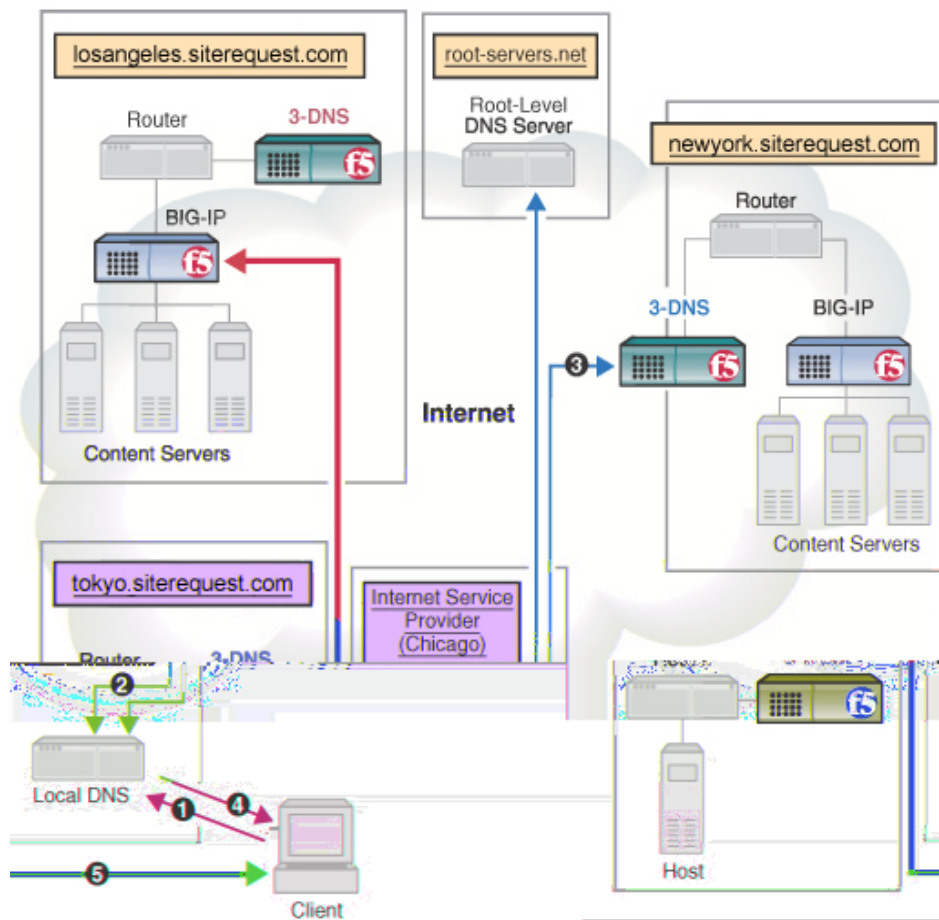

Figure 2.2 DNS name resolution process

Figure 2.2 illustrates the specific steps in the name resolution process.

1. The client connects to an Internet Service Provider (ISP) and queries the local DNS server to resolve the domain name **www.siterequest.com**.
2. If the information is not already in the LDNS server's cache, the local DNS server queries a root server (such as InterNIC's root servers). The root server returns the IP address of the DNS systems associated with **www.siterequest.com**, which in this case runs on the 3-DNS Controller.
3. The LDNS then connects to one of the 3-DNS Controllers to resolve the **www.siterequest.com** name. The 3-DNS Controller uses a load balancing mode to choose an appropriate virtual server to receive the connection, and then returns the virtual server's IP address to the LDNS.
4. The LDNS caches the answer from the 3-DNS Controller, and passes the IP address to the client.
5. The client connects to the IP address through an ISP.

Load balancing connections across the network

Each of the load balancing modes on the 3-DNS Controller can provide efficient load balancing for any network configuration. The 3-DNS Controller bases load balancing on pools of virtual servers. When a client requests a DNS resolution, the 3-DNS Controller uses the specified load balancing mode to choose a virtual server from a pool of virtual servers. The resulting answer to this resolution request is returned as a standard **A** record.

Although some load balancing configurations can get complex, most load balancing configurations are relatively simple, whether you use a static load balancing mode or a dynamic load balancing mode. More advanced configurations can incorporate multiple pools, as well as advanced traffic control features, such as topology or production rules.

For more information on specific load balancing modes, see Chapter 2, *Load Balancing* in the **3-DNS Reference Guide**. For more information on load balancing configurations, review the sample configurations in Chapter 6, *Configuring a Globally-Distributed Network*, and Chapter 7, *Configuring a Content Delivery Network*. If you are unfamiliar with the 3-DNS Controller, you may also want to review Chapter 5, *Essential Configuration Tasks*.

Working with 3-DNS Controllers and other products

The 3-DNS Controller distributes connections across a group of virtual servers that run in different data centers throughout the network. You can manage virtual servers from the following types of products:

- ◆ **BIG-IP systems**

A BIG-IP virtual server maps to a series of content servers.

- ◆ **EDGE-FX systems**
An EDGE-FX virtual server maps to cached content that gets refreshed at frequent intervals.
- ◆ **Generic host**
A host virtual server can be an IP address or an IP alias that hosts the content.
- ◆ **Other load balancing hosts**
Other load balancing hosts map virtual servers to a series of content hosts.

Figure 2.3 illustrates the hierarchy of how the 3-DNS Controller manages virtual servers.

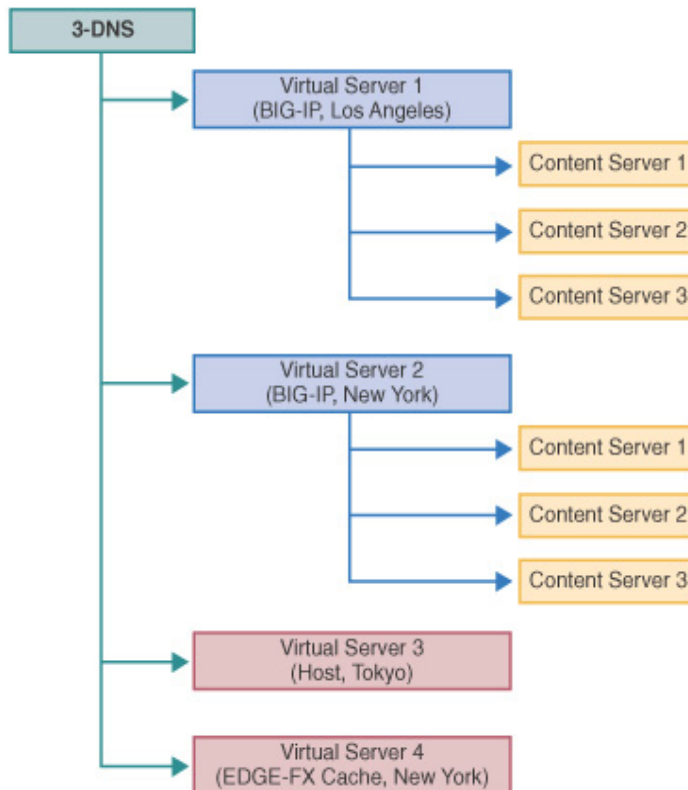

Figure 2.3 Load balancing management on a 3-DNS Controller

Planning issues for the network setup

After you finish running the Setup utility, and connect each system to the network, you can set up the network and load balancing configuration on one 3-DNS Controller, and let the sync group feature automatically broadcast the configuration to the other 3-DNS Controllers in the network. You do not have to configure the 3-DNS Controllers individually, unless you are planning an advanced configuration that requires different configurations for different data centers, or you are configuring the 3-DNS Controllers from the command line.

◆ Tip

*If you are configuring additional 3-DNS Controllers in a network that already has a 3-DNS Controller in it, please review Chapter 10, **Adding a 3-DNS Controller to an Existing Network**.*

During the network setup phase, you define four basic aspects of the network layout, in the following order:

- **Base network**
The base network includes the interfaces, VLANs, and trunks for the network topology. Configuring the base network installs the 3-DNS Controller in your physical network.
- **Data centers**
Data centers are the physical locations that house the equipment you use for load balancing.
- **Data center servers**
The data center servers that you define in the network setup include the 3-DNS Controller, BIG-IP systems, EDGE-FX systems, and host systems that you use for load balancing and probing.
- **Sync group**
A *sync group* defines the group of 3-DNS Controllers that shares configuration settings.

◆ Note

During the setup phase of configuration, we recommend that you connect to the 3-DNS Controller from a remote workstation from which you can complete the remaining configuration tasks using the web-based Configuration utility.

Configuring the base network

The 3-DNS Controller interfaces and the related topics of self IP addresses, VLANs, and trunks are collectively referred to, in this manual, as the **base network**. The base network, or at least an initial version of it, is configured when you run the Setup utility for the first time. The initial base network configuration also includes such things as the default route for the 3-DNS Controller, fully qualified domain names, and certificate information that

can only be configured using the Setup utility or its components. (To make changes to other base network components, such as domain names, default routes, and certificate information, refer to Chapter 3, *Using the Setup Utility*, which describes the Setup utility and its various components.)

A 3-DNS usually has two network interfaces. Each active interface must be configured with a VLAN membership, and each VLAN must have a self IP address. Note that most 3-DNS configurations require only one interface, VLAN, and self IP address. However, if you are configuring the 3-DNS Controller in bridge mode or router mode, you may need to configure two (or more) interfaces, depending on your network requirements. For more information on configuring the base network, refer to Chapter 4, *Post-Setup Tasks*.

Defining data centers and servers

In the 3-DNS configuration, it is important that you define all of your data centers before you begin defining the data center servers. This is because when you define a server, you specify the data center where the server runs. (You do this by choosing a data center from the list of data centers you have already defined.) To define a data center, you need only specify the data center name. To define a server, however, you need to specify the following items:

- Server type (3-DNS Controller, BIG-IP system, EDGE-FX system, router, or host)
- Server IP address (or shared IP alias for redundant systems)
- Name of the data center where the server runs
- The **big3d** agent factories (on 3-DNS Controller, BIG-IP system, and EDGE-FX systems only)
- Virtual servers managed by the server (BIG-IP system, EDGE-FX system, and host systems only)
- SNMP host probing settings (hosts only)

◆ Note

*One important aspect of planning your network setup is to decide how to set up the **big3d** agent, and which ports you need to open for communications between the systems in your network. See the **3-DNS Reference Guide**, Chapter 5, **Probing and Metrics Collection**, for help with determining how both of these issues affect your installation.*

Planning a sync group

A **sync group** is a group of 3-DNS Controllers that share configuration information. In a sync group, a **principal** 3-DNS Controller issues requests to the **big3d** agents on all the other systems to gather metrics data. Both the principal 3-DNS Controller and the **receiver** 3-DNS Controllers in the sync

group receive broadcasts of metrics data from the **big3d** agents. All members of the sync group also receive broadcasts of updated configuration settings from the 3-DNS Controller that has the latest configuration changes.

When you define the sync group, you select the sync group members from the list of 3-DNS Controllers you have already defined. The sync group lists the 3-DNS Controllers in the order in which you selected them. The first 3-DNS Controller in the list becomes the principal 3-DNS Controller. The remaining 3-DNS Controllers in the list become receivers. If the principal 3-DNS Controller becomes disabled, the next 3-DNS Controller in the list becomes the principal 3-DNS Controller until the original principal 3-DNS Controller comes back online.

Understanding how a sync group works

The sync group feature synchronizes individual configuration files, such as **wideip.conf**, and other files that store system settings. You have the option of adding files to the synchronization list.

The 3-DNS Controllers in a sync group operate as peer servers. At set intervals, the **syncd** utility compares the time stamps of the configuration files earmarked for synchronization on all of the 3-DNS Controllers. If the time stamp on a specific file differs between 3-DNS Controllers, the 3-DNS Controller with the latest file broadcasts the file to all of the other 3-DNS Controllers in the group.

Understanding how the time tolerance variable affects a sync group

The time tolerance variable is a global variable that defines the number of seconds that the time setting on one 3-DNS Controller can be ahead or behind the time setting on another 3-DNS Controller. If the difference between the times on the systems is greater than the time tolerance, the time setting on the 3-DNS Controller running behind is reset to match the 3-DNS Controller with the most recent time. For example, if the time tolerance is 5 seconds, and one 3-DNS Controller is running 10 seconds ahead of the other, the 3-DNS Controller running behind has its time reset to match the one running 10 seconds ahead. If the second system was running only 2 seconds ahead of the other, the time settings would remain unchanged. The values are 0, 5, and higher (values of 1-4 are automatically set to 5, and 0 turns off time synchronization). The default setting is **10** seconds.

The time setting on 3-DNS Controllers is important because a 3-DNS Controller compares time stamps on files when deciding whether to synchronize files with other 3-DNS Controllers in the sync group.

Setting up communications on a 3-DNS Controller

There are three different communication issues that you need to resolve when you set up communication between the 3-DNS Controllers running in your network.

- ◆ **3-DNS Controllers communicating with other 3-DNS Controllers**
To allow 3-DNS Controllers to communicate with each other, you must set up **ssh** and **scp** utilities.
- ◆ **3-DNS Controllers communicating with BIG-IP systems and EDGE-FX systems**
To allow the 3-DNS Controller to communicate with BIG-IP systems and EDGE-FX systems, you address the same **ssh** issues.
- ◆ **3-DNS Controllers communicating with big3d agents**
To allow communications between **big3d** agents and the 3-DNS Controller, you need to configure iQuery ports on any 3-DNS Controllers, BIG-IP systems, and EDGE-FX systems that run the **big3d** agent.

Setting up communication between crypto and non-crypto systems

The 3-DNS Controllers in your network need to communicate with each other in order to synchronize configuration and performance data. If you use exclusively crypto 3-DNS Controllers (those that use the SSH protocol) the communication tools set up by the Setup utility are all you need.

If your network is a mixed environment, that is, composed of both crypto and non-crypto systems, you need to enable the **rsh** and **rcp** utilities on the crypto systems. Though the **rsh** and **rcp** utilities come pre-installed on the crypto systems, you must explicitly enable these utilities. You can enable the utilities using the Setup utility. Table 2.1 shows the ports and protocols used for SSH and RSH communications between crypto and non-crypto systems.

From	To	Protocol	From Port	To Port	Connection
Crypto	Crypto	TCP	<1024	22	SSH/SCP
Crypto	Non-crypto	TCP	<1024	514	RSH/RCP
Non-crypto	Crypto	TCP	<1024	514	RSH/RCP
Non-crypto	Non-crypto	TCP	<1024	514	RSH/RCP

Table 2.1 SSH and RSH communications ports and protocols

Setting up data collection with the big3d agent

The **big3d** agent collects performance information from other 3-DNS Controllers, BIG-IP systems, and EDGE-FX systems on behalf of the 3-DNS Controller you are configuring. The 3-DNS Controller then uses this performance data for load balancing. The **big3d** agent uses factories to manage the data collection. For detailed information on configuring the

big3d agent, managing the factories, opening the UDP ports, and working with firewalls, review Chapter 5, *Probing and Metrics Collection*, in the *3-DNS Reference Guide*.

Choosing the 3-DNS mode

The 3-DNS Controller can run in one of three modes: node, bridge, or router. The base network configuration changes depending on which mode you choose. The following sections describe the three modes and provide basic configuration examples.

Running a 3-DNS Controller in node mode

Node mode is the traditional way to configure the 3-DNS Controller. The benefits of running the 3-DNS Controller in node mode are as follows:

- You can replace your name servers with 3-DNS Controllers.
- You can use the 3-DNS Controller as the authoritative DNS server for your domain.
- You can manage your DNS zone files with NameSurfer.

When you replace your DNS servers with 3-DNS Controllers, you can use the extensive wide-area traffic management capabilities of the 3-DNS Controller in conjunction with the standard DNS protocol. When the 3-DNS Controller receives a request that matches a wide IP, it routes that request to the best virtual server in your network. When a 3-DNS Controller receives a non-matching request, that request is handled by the BIND utility (**named**) that is running on the 3-DNS Controller.

When you configure the 3-DNS Controller to be authoritative for your domain, you can easily manage DNS zone files using NameSurfer, a browser-based, third-party application included on the 3-DNS Controller. When you define wide IPs in the Configuration utility, the NameSurfer application automatically makes the appropriate additions to the zone files. The changes are then broadcast to the other 3-DNS Controllers in your network.

◆ **Note**

If you configure wide IPs from the command line, you need to make the corresponding zone file changes from the command line.

Using the 3-DNS synchronization features

If you use the advanced synchronization features of the 3-DNS Controller, we strongly recommend that you configure each 3-DNS Controller to run as authoritative for the domain. This type of configuration offers the following advantages:

- You can change zone files on any one of the 3-DNS Controllers in the network and have those changes automatically broadcast to all of the other systems in the network.
- Each 3-DNS Controller has the most up-to-date zone files, providing you one or more layers of redundancy.
- The NameSurfer application automatically controls the addition, configuration, and deletion of zone files.

Importing BIND files to NameSurfer during an initial installation

During the initial configuration, you can specify that the 3-DNS Controller import any existing BIND files from your name server to the 3-DNS Controller. During the initial configuration, you can also designate NameSurfer as the primary name server for your domain. This forces NameSurfer to automatically format your BIND files in the NameSurfer format. For more information, refer to the NameSurfer documentation available from the home screen in the Configuration utility.

Running a 3-DNS Controller in bridge mode or router mode

Running the 3-DNS Controller in bridge mode or router mode offers the following benefits:

- You gain the wide-area traffic management capabilities of the 3-DNS Controller without disrupting your current DNS system.
- In an enterprise, you can install, configure, and test the 3-DNS Controller before you add the system to your production environment.
- You do not use NameSurfer to manage your zone files.
- You can load balance requests across two separate IP networks.

When you configure the 3-DNS Controller in bridge mode, you install the 3-DNS Controller into your network so that all DNS requests are intercepted by the 3-DNS Controller before they are sent to your name server for resolution. Based on the content of the request, the 3-DNS Controller does one of the following:

- If the request matches a wide IP managed by the 3-DNS Controller, the system responds to the request with the best available virtual server in your network.
- If the request does not match any wide IPs managed by the 3-DNS Controller, the system forwards the request to the DNS server for resolution.



3

Using the Setup Utility

- Creating the initial software configuration with the Setup utility
- Connecting to the 3-DNS Controller for the first time
- Using the Setup utility for the first time
- Running the Setup utility after creating the initial software configuration

Creating the initial software configuration with the Setup utility

Once you install and connect the hardware and obtain a license, the next step in the installation process is to turn the system on and run the Setup utility. The Setup utility defines the initial configuration settings required to install the 3-DNS Controller into the network. You can run the Setup utility remotely from a web browser, or from an SSH or Telnet client, or you can run it directly from the console.

Before you connect to the unit, we recommend that you gather the list of information outlined in the configuration worksheet provided with the 3-DNS Controller. Note that the screens you see are tailored to the specific hardware and software configuration that you have. For example, if you have a stand-alone system, the Setup utility skips the redundant system screens.

Once you have configured the base network elements with the Setup utility, you might want to further enhance the configuration of these elements. For additional information about these configuration tasks, see Chapter 4, *Post-Setup Tasks*.

The license file installed on the system must be compatible with the latest version of the 3-DNS software before you run the Setup utility. If it is not, you must update the license using the registration key provided to you by your vendor. If you do not have a registration key, please contact your vendor to obtain one. If you choose to continue without obtaining a license, the 3-DNS software will not be fully functional.

Connecting to the 3-DNS Controller for the first time

The Setup utility prompts you to enter the same information, whether you run the utility from a web browser, or from the command line. If you run the utility from the console, no reboot is necessary; if you run the utility from the web, the unit reboots automatically; if you run the utility from an SSH client, we recommend that you reboot the unit after you complete the setup. This reboot automatically removes the default IP address and root password provided specifically for the purposes of running the Setup utility remotely. The 3-DNS software replaces the default IP address and root password with the password and IP addresses that you define while running the utility.

Running the utility from the console or serial terminal

Before you can run the Setup utility from either the console or a serial terminal, you must first log in. Use the following default user name and password to log in.

Username: **root**

Password: **default**

After you log in, you can start the utility directly from the console or serial terminal by typing the command **setup**.

Running the Setup utility remotely

You can run the Setup utility remotely only from a workstation that is on the same LAN as the unit. To allow remote connections for the Setup utility, the 3-DNS software comes with two pre-defined IP addresses, and a pre-defined root password. The default root password is **default**, and the preferred default IP address is **192.168.1.245**. If this IP address is unsuitable for your network, the 3-DNS software uses an alternate IP address, **192.168.245.245**. However, if you define an IP alias on an administrative workstation in the same IP network as the 3-DNS Controller, the unit detects the network of the alias and uses the corresponding default IP address.

Once the utility finishes and the system reboots, these default IP addresses are replaced by the information that you entered in the Setup utility.

Setting up an IP alias for the default IP address before you start the unit

You must set up an IP alias for your remote workstation before you turn on the unit and start the Setup utility. The remote workstation must be on the same IP network as the unit. If you add this alias prior to booting up the 3-DNS Controller, the unit detects the alias and uses the corresponding address.

To set up an IP alias for the alternate IP address

The IP alias must be in the same network as the default IP address you want the 3-DNS Controller to use. For example, on a UNIX workstation, you might create one of the following aliases:

- ◆ If you want the unit to use the default IP address **192.168.1.245**, then add

4. On the Configuration Status screen, click **Setup Utility**.
5. Fill out each screen using the information from the Setup utility configuration list. After you complete the Setup utility, the 3-DNS Controller reboots and uses the new settings you defined.

◆ **Note**

You can rerun the Setup utility from a web browser at any time by clicking the Setup utility link on the welcome screen.

Starting the utility from the command line

You can run the command line version of the Setup utility from the console or serial terminal, or from a remote SSH client, or from a Telnet client.

To start the Setup utility from the console

1. At the login prompt, type **root** for the user name, and **default** for the password.
2. At the 3-DNS prompt, type the following command to start the command-line based Setup utility.
setup
3. Fill out each screen using the information from the Configuration worksheet. After you complete the Setup utility, the 3-DNS Controller uses the new settings you defined.

To start the Setup utility from the command line from a remote administrative workstation

1. Start an SSH client on a workstation connected to the same IP network as the internal VLAN of the unit. (See Chapter 4, *Post-Setup Tasks*, for information on downloading the SSH client from the 3-DNS Controller.)
2. Type the following command, where **<default IP>** is the IP address in use on the 3-DNS internal VLAN.
ssh <default IP>
3. At the login prompt, type **root** for the user name, and **default** for the password.
4. At the 3-DNS prompt, type the following command to start the command-line based Setup utility.
setup
5. Fill out each screen using the information from the Configuration worksheet. After you complete the Setup utility, reboot the 3-DNS Controller by typing the following command:
reboot

◆ Note

*You can rerun the Setup utility at any time using the **setup** command.*

Using the Setup utility for the first time

The following sections provide detailed information about the settings that you define in the Setup utility.

Keyboard type

Select the type of keyboard you want to use with the 3-DNS Controller. The following options are available:

- Belgian
- Bulgarian MİK
- French
- German
- Japanese - 106 key
- Norwegian
- Spanish
- Swedish
- US + Cyrillic
- US - Standard 101 key (default)
- United Kingdom

Root password

A root password allows you command line administrative access to the 3-DNS Controller. We recommend that the password contain a minimum of 6 characters, but no more than 32 characters. Passwords are case-sensitive, and we recommend that your password contain a combination of upper- and lower-case characters, as well as numbers and special characters (for example, !@#% ^&*). Once you enter a password, the Setup utility prompts you to confirm your root password by typing it again. If the two passwords match, your password is immediately saved. If the two passwords do not match, the Setup utility provides an error message and prompts you to re-enter your password.

Host name

The host name identifies the 3-DNS Controller itself. Host names must be fully qualified domain names (FQDNs). The host portion of the name must start with a letter, and must be at least two characters. The FQDN must be less than or equal to 256 characters, but not less than 1 character. Each label part of the name must be 63 characters or fewer. Only letters, numbers, and the characters underscore (_), dash (-), and period (.) are allowed. For example:

```
<host 63 characters or less>.<label 63 characters or less>.net
```

You should only change the host name of the system with the Setup utility. Editing `/etc/hosts`, or using the `hostname` command to change the host name renders the system inaccessible.

Redundant system settings

There are three types of settings you need to define for redundant systems: unit IDs, fail-over IP addresses, and fail-over type.

Unit IDs

The default unit ID number is **1**. If this is the first unit in the redundant system, use the default. When you configure the second unit in the system, type **2**. These unit IDs are used for active-active redundant configuration.

Choosing a fail-over IP address

A fail-over IP address is the IP address of the unit that takes over if the current unit fails. Type in the IP address configured on the internal interface of the other 3-DNS unit in the redundant system.

Fail-over type

There are two types of fail-over to choose from: hard-wired fail-over, and network fail-over. Choose hard-wired fail-over if you plan to connect the units together with the fail-over cable provided with the redundant system. Choose network fail-over if you plan to use the network that the units are connected to for fail-over functionality.

◆ **Note**

Hard-wired fail-over is only available if the platform supports hard-wired fail-over.

Setting the interface media type

Configure media settings for each interface. The media type options depend on the network interface card included in your hardware configuration. The Setup utility prompts you with the settings that apply to the interface installed in the unit. The 3-DNS Controller supports the following types:

- auto
- 10baseT
- 10baseT, FDX
- 100baseTX
- 100baseTX, FDX
- Gigabit Ethernet

◆ **Note**

*For best results, choose the **auto** setting. In some cases, devices configured for the auto media are incompatible, and the proper duplex setting will not be negotiated. In these cases you may need to set the media settings to the same speed and duplex on this device and the corresponding switch or host. Check your switch or hub documentation for this information.*

The Setup utility lists only the network interface devices that it detects during system boot. If the utility lists fewer interface devices than you expected, a network adapter may have come loose during shipping. Check the LED indicators on the network adapters to ensure that they are working and are connected.

Configuring VLANs and IP addresses

You can create a new VLAN or use the default VLANs to create the 3-DNS Controller configuration.

Determine whether you want to have security **enabled** for a VLAN, or **disabled** for the VLAN. Then, type the IP address settings for the VLAN. The IP address settings include:

- Port Lockdown settings
- IP address, netmask, and broadcast
- Floating self IP address, netmask, and broadcast

◆ **Note**

We recommend that you set the floating self IP address as the default route for target devices, such as servers. The floating self IP address is owned by the active unit in an active/standby configuration.

◆ **Note**

The IP address of the external VLAN is not the IP address of your site or sites. The IP addresses of the sites themselves are specified by the virtual IP addresses associated with each virtual server you configure.

Assigning interfaces to VLANs

After you configure the VLANs that you want to use on the 3-DNS Controller, you can assign interfaces to the VLANs. If you use the default internal and external VLANs, we recommend that you assign at least one interface to the external VLAN, and at least one interface to the internal VLAN. The external VLAN is the one on which the 3-DNS Controller receives connection requests. The internal VLAN is typically the one that is connected to the network of servers, firewalls, or other equipment that the 3-DNS Controller load balances.

Associating the primary IP address and VLAN with the host name

After you assign interfaces to VLANs, and if you have more than one VLAN defined, you can choose one VLAN/IP address combination as the primary IP address to associate with the unit host name.

Configuring a default gateway pool

If a 3-DNS Controller does not have a predefined route for network traffic, the unit automatically sends traffic to the pool that you define as the default gateway pool. You can think of the default gateway pool as a pool of default routes. Typically, a default gateway pool is set to two or more gateway IP addresses. If you type more than one default gateway IP address, the additional gateways provide high availability for administrative connections. The first address you type becomes the default route. If a gateway in the default gateway pool becomes inactive, existing connections through the inactive gateway are routed through another gateway in the default gateway pool. If you type one IP address, no pool is created, and that address is entered as the default route.

All default gateway IP addresses you add to the default gateway pool must be in the same IP network as the 3-DNS Controller.

Configuring remote web server access

The 3-DNS web server provides the ability to set up remote web access on each VLAN. When you set up web access on a VLAN, you can connect to the web-based configuration utility through the VLAN. To enable web access, specify a fully qualified domain name (FQDN) for each VLAN. The

3-DNS web server configuration also requires that you define a password for the **admin** user. If SSL is available, the configuration also generates authentication certificates.

◆ **Note**

If the host name portion of the FQDN is greater than 64 characters, the 3-DNS software cannot use it for the web server FQDN.

The Setup utility guides you through a series of screens to set up remote web access.

- The first screen prompts you to select the VLAN you want to configure for web access. After you select an interface to configure, the utility prompts you to type a fully qualified domain name (FQDN) for the interface. You can configure web access on one or more interfaces.
- After you configure the interface, the utility prompts you for a password for the **admin** user account.
- After you type a password for the **admin** user account, you have the option to type the IP addresses from which web-interface connections are allowed.
- After you type the IP addresses that are allowed to access the unit with the **admin** account, the certification screen prompts you for country, state, city, company, and division.

If you ever change the IP addresses or host names on the 3-DNS interfaces, you must reconfigure the 3-DNS web server and the portal to reflect your new settings.

You should add users, or change passwords for existing users, only through the Configuration utility.

*If you have modified the remote web server configuration outside of the Configuration utility, be aware that some changes may be lost when you run the Setup utility. This utility overwrites the **httpd.conf** file and the **openssl.conf** file.*

Configuring remote administrative access

After you configure remote web access, the Setup utility prompts you to configure remote command line access. On most 3-DNS units, the first screen you see is the Configure SSH screen, which prompts you to type an IP address for SSH command line access. If SSH is not available, you are prompted to configure access through Telnet, RSH, and FTP instead.

When the Setup utility prompts you to enter an IP address for administration, you can type a single IP address or a list of IP addresses, from which the 3-DNS Controller will accept administrative connections (either remote shell connections, or connections to the web server on the 3-DNS Controller). To specify a range of IP addresses, you can use the asterisk (*) as a wildcard character in the IP addresses.

The following example allows remote administration from all hosts on the **192.168.2.0/24** network:

```
192.168.2.*
```

◆ **Note**

For administration purposes, you can connect to the 3-DNS floating self IP address, which always connects you to the active unit in an active/standby redundant system. To connect to a specific unit, connect directly to the IP address of that 3-DNS unit.

Setting support access

Next, the Setup utility prompts you to set up a support access account. If you would like to activate a support access account to allow your vendor access to the 3-DNS unit, type a password for the support account. Next, select the access type you want for the support account.

Setting the time zone

Next, you need to specify your time zone. This ensures that the clock for the 3-DNS Controller is set correctly, and that dates and times recorded in log files correspond to the time zone of the system administrator. Scroll through the list to find the time zone at your location. Note that one option may appear with multiple names. Select the time zone you want to use, and press the Enter key to continue.

Configuring NTP support

You can synchronize the time on the unit to a public time server by using Network Time Protocol (NTP). NTP is built on top of TCP/IP and assures accurate, local timekeeping with reference to clocks located on the Internet. This protocol is capable of synchronizing distributed clocks, within milliseconds, over long periods of time. If you choose to enable NTP, make sure UDP port **123** is open in both directions when the unit is behind a firewall.

Configuring the 3-DNS mode

The 3-DNS Controller can run in three different modes: node, bridge, and router.

- ◆ **Node mode**

The *node mode* is the traditional installation of the 3-DNS Controller. The 3-DNS Controller replaces a DNS server in a network and uses the DNS server's IP address. All DNS traffic is directed at the 3-DNS Controller because it is registered with InterNIC as authoritative for the domain. In node mode, you usually run BIND on the system to manage DNS zone files. In node mode, you may also use the NameSurfer application available to manage your zone files.

- ◆ **Bridge mode**

In *bridge mode*, the 3-DNS Controller acts as an IP bridging device by forwarding packets between two LAN segments (usually on the same IP subnet). The system usually has one IP address, and is installed between the router or switch, and the authoritative DNS server. The 3-DNS Controller does not replace the authoritative DNS server.

The 3-DNS Controller filters all DNS packets that match wide IPs, and forwards the remaining packets to the authoritative DNS server for resolution. Note that this may be the preferred method of using the 3-DNS Controller because you do not have to replace the authoritative DNS server, and you can perform out-of-band testing before you deploy 3-DNS software upgrades.

- ◆ **Router mode**

In *router mode*, the 3-DNS Controller acts as a router by forwarding packets between two different IP subnets. You can put the 3-DNS Controller anywhere in the network topology so that packets destined for the authoritative DNS server have to pass through it. Router mode requires at least two IP addresses and two VLANs. Router mode is probably most useful for Internet service providers (ISPs) that want to redirect traffic to local content servers. For example, by using the 3-DNS Controller in router mode, an ISP can redirect requests for **ads.siterequest.net** to a local ad server.

Configuring user authentication

When you run the Setup utility, you can configure authentication for 3-DNS user accounts either through an external LDAP or RADIUS server, or locally on the 3-DNS Controller. The following sections describe these two authentication options.

- ◆ **Note**

*The **root** and **admin** accounts are always authenticated locally.*

Using the local LDAP database only

When you run the Setup utility, you are not required to configure an external LDAP or RADIUS database to manage user authentication. Instead, you can use the default authentication mechanism, which is the 3-DNS Controller's local LDAP database. In this case, the local LDAP database manages not only authorization for your 3-DNS users, but also authentication. All users subsequently attempting to log on to a 3-DNS Controller must enter a user name and password, which are checked against user data stored in the local database. If the user name and password are found and verified in that database, the user is authenticated.

Configuring the unit to use an external LDAP or RADIUS server

When you run the Setup utility, you can configure an external (remote) server, either LDAP or RADIUS, to manage user authentication for the 3-DNS Controller. When you choose this configuration option, all users subsequently attempting to log on to a 3-DNS Controller must enter a user name and password, which are checked against user data stored in that external database. If the user name and password are found and verified in that database, the user is authenticated.

◆ **Note**

*In the event that authentication fails with an external LDAP or RADIUS server, you can log in with accounts locally, such as the **root** and **admin** accounts.*

Configuring external LDAP authentication

When you configure the unit to use an external LDAP server for user authentication, you need the following information:

- The IP address of the LDAP server, or the IP address of the primary server if you have more than one LDAP server.
- The base distinguished name of each LDAP server. This name must be the same for each server.
- Optionally, the user name of the account that you want to bind to the LDAP server as the search account. The search account is a read-only account used to do searches. This account must be able to access passwords. If you have more than one LDAP server, this account must be the same on each server.
- If you configure an LDAP search account, you need the password for that account. If you have more than one LDAP server, you must use the same search account and password.
- After you configure external authentication, you need to set the authorization level, or role, for each user you want to allow to access the controller. You can do this after you complete the Setup utility. Add an account and role for each user in the User Administration screen of the Configuration utility. Since the external authentication server handles the password authentication, you do not need to enter a password for these

users. For detailed instructions on setting roles for users, see *Managing user accounts*, in Chapter 6, *Administration and Monitoring*, in the *3-DNS Reference Guide*.

Configuring external RADIUS authentication

When you configure the unit to use an external RADIUS server for user authentication you need the following information:

- The IP address of the RADIUS server, or the IP address of the primary server and secondary server if you have more than one RADIUS server.
- The port configured for RADIUS traffic on your RADIUS server. Typically, the port configured for RADIUS is port **1645**, the traditional RADIUS port, or port **1812**, the new official RADIUS port.
- The primary RADIUS secret, and if you have a secondary RADIUS server, the secondary RADIUS secret.
- After you configure external authentication, you need to set the authorization level, or role, for each user you want to allow to access the controller. You can do this after you complete the Setup utility. Add an account and role for each user in the User Administration screen of the Configuration utility. Since the external authentication server handles the password authentication, you do not need to enter a password for these users. For detailed instructions on setting roles for users, see *Managing user accounts*, in Chapter 6, *Administration and Monitoring*, in the *3-DNS Reference Guide*.

Configuring NameSurfer for zone file management

You can configure NameSurfer to handle DNS zone file management. We strongly recommend that you configure NameSurfer to handle zone file management by selecting NameSurfer to be the master on the unit. If you select NameSurfer as the master, NameSurfer converts the DNS zone files on the system, becomes the authoritative DNS, and automatically processes changes and updates to the zone files. (You can access the NameSurfer application directly from the Configuration utility for the 3-DNS Controller.)

In the final series of the Setup utility screens, you choose whether to have NameSurfer handle DNS zone file management on the 3-DNS Controller. If you configure the 3-DNS Controller in node mode, we strongly recommend that you configure NameSurfer to handle zone file management. If you designate NameSurfer as the primary name server, NameSurfer converts the DNS zone files on the system, becomes the authoritative DNS, and automatically processes changes and updates to the zone files. (You can access the NameSurfer application directly from the Configuration utility).

To open the NameSurfer application

1. In the navigation pane, click **NameSurfer**.
The NameSurfer home screen opens.

2. Edit the zone file information as required.
For help with the NameSurfer application, click **Help** in the NameSurfer navigation pane.

◆ **Note**

Remember that if you run the 3-DNS Controller in bridge or router mode, the system is not authoritative for any domains, so the NameSurfer application is not available to manage any zone files.

Running the Setup utility after creating the initial software configuration

You normally run the Setup utility when the system is first installed as part of the installation procedure. However, you can also use the command line Setup utility to change existing settings at any time. This section describes running the Setup utility to change settings after you run it initially.

To run the Setup utility from the command line, type in the following command:

```
setup
```

After you complete the initial configuration, the Setup utility presents a menu of individual configuration options.

The Setup utility menu is divided into two different sections, Required and Optional. The Setup utility includes the following required configuration options:

- Set the default gateway pool
- Configure VLANs and networking
- Set host name
- Configure web servers
- Set the root password

The following configuration selections are optional:

- Configure DNS
- Configure FTP
- Set keyboard type
- Define time servers
- Configure NameSurfer
- Initialize the iControl portal
- Configure RSH
- Configure SSH

- Configure Telnet
- Set time zone
- Remote authentication
- License activation
- Configure remote access (for configuration synchronization)
- Set support access

```

lqq I N I T I A L   S E T U P   M E N U qqqqqqqqqqqqqqqqqqqqqqqqqqqqqqqqqqqqqqqqqk
x
x   Choose the desired configuration function from the list below.           x
x
x   (A) Configure all services           (R) Steps for redundant systems     x
x
x   REQUIRED                             x
x   (E) Set default gateways           (V) Configure VLANs & networking    x
x   (H) Set host name                   (W) Configure web servers          x
x   (P) Set root password               x
x
x   OPTIONAL                             x
x   (C) Remote authentication           (O) Configure remote access       x
x   (D) Configure DNS                   (S) Configure SSH                 x
x   (F) Configure FTP                   (T) Configure Telnetd            x
x   (I) Initialize iControl portal      (U) Configure RSH                 x
x   (K) Set keyboard type               (Y) Set support access            x
x   (L) License Activation              (Z) Set time zone                 x
x   (M) Define time servers             (Q) Quit                          x
x   (N) Configure NameSurfer            x
x
x   Enter Choice:                       x
mqqqqqqqqqqqqqqqqqqqqqqqqqqqqqqqqqqqqqqqqqqqqqqqqqqqqqqqqqqqqqqqqqqqqqqqqqqqqqj

```

Figure 3.1 The Setup utility menu

Options available only through the Setup utility menu

This section contains descriptions of options that are available only through the Setup utility menu. These options include:

- Initializing the iControl portal
- Configuring RSH
- Configuring Telnet
- Configuring FTP

Initialize the iControl portal

This option is available in the menu only after you create the initial software configuration. Select this option to configure the CORBA ports (IIOP and FSSL). This option prompts you for a list of IP addresses or host names you

want to embed as objects in the portal object reference. Typically, in a redundant system, this list includes the fail-over IP address of the other 3-DNS unit in the redundant system.

This option prompts you to set the portal to use IP addresses instead of DNS names. If the portal is set to use IP addresses, the 3-DNS Controller does not have to do a DNS lookup.

In addition to these settings, you can change the following iControl portal settings:

- The security mode of the portal. You can allow the portal to handle non-secure requests.
- The name of the portal object reference file.
- The portal PID file name.

Configuring RSH

This option is available only in the menu after you create the initial software configuration. Use this option to configure the remote shell (**rshd**) server. This utility prompts you for an IP address from which administrators may access the 3-DNS Controller. You can use wildcard characters (*) to include all addresses from a specific part of the network. This utility also prompts you to create a support account for access by technical support.

If **inetd** is not currently configured, this utility configures **inetd** for the remote shell server (**rshd**). If the service port for **rsh** is closed, this utility opens the service port to permit **rsh** connections to the system.

Configuring Telnet

Use this option to configure the Telnet server only on a 3-DNS Controller. The Setup utility prompts you to configure each service independently. This allows you to enable Telnet.

The utility prompts you for a configuration address for each service from which administrators may access the 3-DNS Controller. You can use wildcard characters (*) to include all addresses from a specific part of the network. This utility also prompts you to create a support account for access by technical support.

If **inetd** is not currently configured, this utility configures **inetd** for the requested services. If the ports for Telnet are closed, this utility opens the ports to permit Telnet connections to the 3-DNS Controller.

Configuring FTP

Use this option to configure FTP on the 3-DNS Controller. The Setup utility prompts you for an IP address from which administrators may access the 3-DNS Controller with FTP. You can use wildcard characters (*) to include all addresses from a specific part of the network. This utility also prompts you to create a support account for access by technical support.

If the service port for FTP is closed, this utility opens the service port to permit FTP connections to the 3-DNS Controller.

Although you can configure FTP and Telnet on a 3-DNS Controller, we recommend that you leave these services disabled, for security reasons.



4

Post-Setup Tasks

- Introduction
- Configuring the interfaces
- Working with VLANs
- Configuring a self IP address

Introduction

Setting up the base network for the 3-DNS Controller means configuring elements such as the 3-DNS Controller host name, a default gateway pool, interface media settings, and VLANs and self IP addresses. Configuration tasks for the BIG-IP base network are performed using the Setup utility. For information on using the Setup utility, see Chapter 3, *Using the Setup Utility*.

Once you have configured the base network elements with the Setup utility, you might want to further enhance the configuration of these elements. This chapter provides the information you need to perform these additional configuration tasks. You can perform these tasks using either the Configuration utility or the **bigpipe** command line utility.

Elements you might want to further configure after running Setup are:

- ◆ **Interfaces**

You can set the media type and the duplex mode for an interface, as well as display interface status.

- ◆ **VLANs**

VLAN options include tagging, and assigning interfaces to VLANs. In addition, you can group separate VLANs together for the purpose of bridging packets between them.

- ◆ **Self IP addresses**

You can change self IP addresses or create any number of additional self IP addresses for a VLAN.

- ◆ **Additional host names**

You can insert additional host names and IP addresses for network devices into the `/etc/hosts` file. For example, you can insert host names for the IP addresses that you will assign to virtual servers, and host names for standard devices such as your routers, network interface cards, and servers.

- ◆ **General networking**

You can configure a default route, as well as dynamic routing, DNS, and email.

- ◆ **Note**

Once you have configured the base network, you can configure the high-level network. Examples of elements you configure as part of the high-level network are: Pools, rules, proxies, and network address translation (SNATs and NATs).

Configuring the interfaces

Typically, a 3-DNS Controller has two network interfaces. The following sections describe the naming convention, displaying the status, setting the media type, and setting the duplex mode for the interfaces in the 3-DNS Controller.

Understanding the interface naming convention

By convention, the Ethernet interfaces on a 3-DNS Controller take the name **<s>.<p>** where **s** is the slot number of the NIC, and **p** is the port number on the NIC. For the 2U platform, slot numbering is top-to-bottom, and port numbering is left-to-right as shown in Figure 4.1.

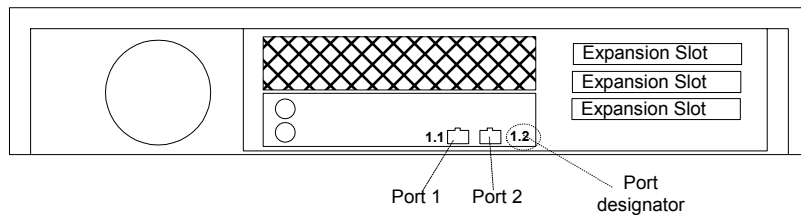

Figure 4.1 Rear view of a 3-DNS Controller with two interface ports

Displaying status for interfaces

Use the following syntax to display the current status and the settings for the installed interface cards:

```
b interface show
```

Figure 4.2 is an example of the output you see when you issue this command.

interface	speed	pkts	pkts	pkts	pkts	bits	bits	errors	trunk	STP
	Mb/s	in	out	drop	coll	in	out			
1.1	UP 100 HD	0	213	0	0	0	74.2K	0		
2.1	UP 100 HD	20	25	0	0	28.6K	33.9K	0		

Figure 4.2 The *bigpipe interface show* command output

Use the following syntax to display the current status and the setting for a specific interface.

```
b interface <if_name> show
```

Setting the media type

You can set the media type for the interface card either to the specific media type or to **auto** for auto detection. If the media type is set to **auto** and the card does not support auto detection, the default type for that interface is used, for example **100BaseTX**.

Use the following syntax to set the media type:

```
b interface <if_name> media <media_type> | auto
```

(Default media type is **auto**.)

◆ Note

*If the 3-DNS Controller is inter-operating with an external switch, the media setting should match that of the switch. To accomplish this, it is best to specify the setting explicitly, and not rely on automatic detection using **auto**.*

Setting the duplex mode

You can set duplex mode to full or half duplex. If the media type does not allow duplex mode to be set, this is indicated by an onscreen message. If media type is set to **auto**, or if setting duplex mode is not supported for the interface, the duplex setting is not saved to **bigip.conf**.

Use the following syntax to set the duplex mode:

```
b interface <if_name> duplex full | half | auto
```

(Default mode is **auto**.)

◆ Note

*If the 3-DNS Controller is inter-operating with an external switch, the media setting should match that of the switch. To accomplish this, it is best to specify the setting explicitly, and not rely on automatic detection using **auto**.*

Working with VLANs

A *VLAN* is a grouping of separate 3-DNS Controller networks that allows those networks to behave as if they were a single local area network, whether or not there is a direct ethernet connection between them.

The 3-DNS Controller offers several options that you can configure for a VLAN. These options are summarized in Table 4.1.

Option	Description
Create a default VLAN configuration	You can use the Setup utility to create a default VLAN configuration.
Create, rename, or delete VLANs	You can create, rename, or delete a VLAN.
Configure packet access to VLANs	Through an option called tagging , you can direct packets from multiple VLANs to a specific 3-DNS interface, or direct traffic from a single VLAN to multiple interfaces.
Manage the L2 forwarding table	You can edit the L2 forwarding table to enter static MAC address assignments.
Create VLAN groups	You can create a VLAN group to allow layer 2 packet forwarding between VLANs.
Set VLAN security	You can set port lockdown by VLAN.
Set fail-safe timeouts	You can set a fail-safe timeout on a VLAN. You can use a fail-safe timeout to trigger fail-over in a redundant system.
Set self IP addresses	You can set one or more self IP addresses for VLANs.
Set MAC masquerade	You can use the MAC masquerade to set up a media access control (MAC) address that is shared by a redundant system.
Configure VLAN mirroring	You can configure the 3-DNS Controller to replicate packets received by a VLAN and send them to another VLAN or set of VLANs.

Table 4.1 Configuration options for VLANs

Default VLAN configuration

By default, the Setup utility configures each interface on the 3-DNS Controller as a member of a VLAN. The 3-DNS Controller identifies the fastest interfaces, makes the lowest-numbered interface in that group a member of the VLAN **external**, and makes all remaining interfaces members of the VLAN **internal**.

VLAN external

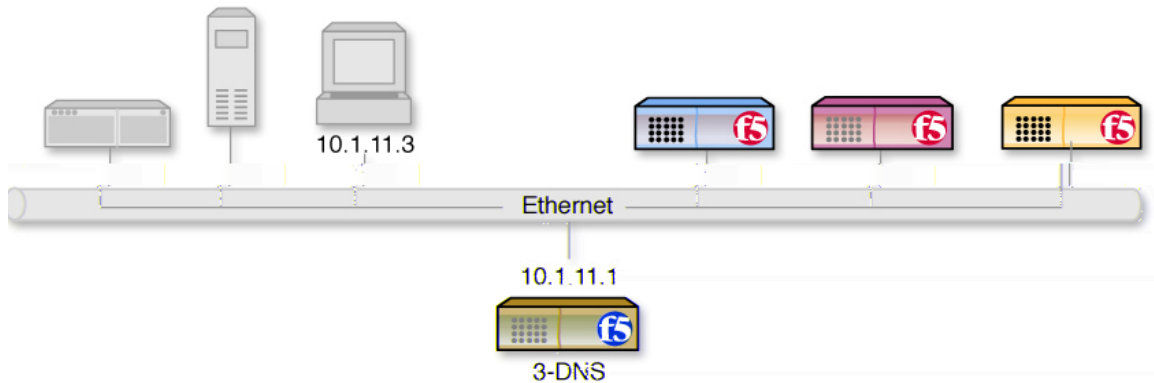

Figure 4.3 Simple VLAN configuration for a 3-DNS Controller

VLAN flexibility is such that separate IP networks can belong to a single VLAN, while a single IP network can be split among multiple VLANs. (The latter case allows the 3-DNS Controller to be inserted into an existing LAN without renaming the nodes.) The VLANs named **external** and **internal** are separate networks, and in the configuration shown they behave like separate networks. The networks belonging to VLAN **internal** are also separate networks, but have been made to behave like a single network. This is accomplished using a feature called VLAN bridging.

Your default VLAN configuration is created using the Setup utility. On a typical unit with two interfaces, you create an internal and external VLAN.

Creating, renaming, and deleting VLANs

Typically, if you use the default configuration, one VLAN is assigned to each interface. However, if you need to change your network configuration, or if the default VLANs are not adequate for a network configuration, you can create new VLANs, rename existing VLANs, or delete a VLAN.

To create a VLAN using the Configuration utility

1. In the navigation pane, click **Network**.
The VLANs screen opens.
2. Click the **Add** button.
3. Type the attributes for the VLAN.
4. Click **Done**.

To rename or delete a VLAN using the Configuration utility

1. In the navigation pane, click **Network**.
The VLANs screen opens.
2. In the VLANs screen, use one of the following options:
 - To rename a VLAN, click the VLAN name you want to change.
The VLAN properties screen opens. Type the new name in the **VLAN name** box.
 - To delete a VLAN, click the **Delete** button for the VLAN you want to delete.
3. Click **Done**.

To create, rename, or delete a VLAN from the command line

To create a VLAN from the command line, use the following syntax:

```
b vlan <vlan name> interfaces add <if name> <if name>
```

For example, if you want to create a VLAN named **myvlan** that contains the interfaces **1.1** and **1.2**, type the following command:

```
b vlan myvlan interfaces add 1.1 1.2
```

To rename an existing VLAN, use the following syntax:

```
b vlan <vlan name> rename <new vlan name>
```

For example, if you want to rename the VLAN **myvlan** to **yourvlan**, type the following command:

```
b vlan myvlan rename yourvlan
```

To delete a VLAN, use the following syntax:

```
b vlan <vlan name> delete
```

For example, to delete the VLAN named **yourvlan**, type the following command:

```
b vlan yourvlan delete
```

Configuring packet access to VLANs

The 3-DNS Controller supports two methods for sending and receiving packets through an interface that is a member of one or more VLANs. These two methods are:

- ◆ **Port-based access to VLANs**

Packets are accepted for a VLAN because the packets have no tags in their headers and were received on an interface that is a member of a VLAN. With this method, an interface is configured as an *untagged* member of the VLAN. Packets sent out through untagged interfaces contain no tag in their header.

- ◆ **Tag-based access to VLANs**

Packets are accepted for a VLAN because the packets have tags in their headers and the tag matches the VLAN identification number for the VLAN. With this method, an interface is configured as a *tagged* member of the VLAN. Packets sent out through tagged interfaces contain a tag in their header.

The sending/receiving method used by a VLAN is determined by the way that you add a member interface to a VLAN. When creating a VLAN or modifying VLAN properties (using the Configuration utility or the **bigpipe** command), you can add an interface to that VLAN as either an untagged or a tagged interface.

The following two sections describe these two methods of providing packet access to a VLAN.

Port-based access to VLANs

Port-based access to VLANs occurs when an interface is added to a VLAN as an *untagged* interface. In this case, the interface can be added only to that VLAN and to no others. This limits the interface to accepting traffic only from that VLAN, instead of from multiple VLANs. To solve this problem, 3-DNS Controller allows you to configure a feature known as tagging, described in the following section.

Tag-based access to VLANs

Tag-based access to VLANs occurs when an interface is added to a VLAN as a tagged interface. A *tagged* interface can be added to multiple VLANs, thereby allowing the interface to accept traffic from each VLAN of which the interface is a member.

When you add an interface to a VLAN as a tagged interface, the 3-DNS Controller associates the interface with the VLAN identification number, or *tag*, which becomes embedded in a header of a packet.

- ◆ **Note**

Every VLAN has a VLAN identification number. This identification number is assigned to a VLAN either explicitly by a user when creating the VLAN, or automatically by the 3-DNS Controller if the user does not supply one.

Each time you add an interface to a VLAN, either when creating a VLAN or modifying its properties, you can designate that interface as a tagged interface. A single interface can therefore have multiple tags associated with it.

The result is that whenever a packet comes into that interface, the interface reads the tag that is embedded in a header of the packet. If the tag in the packet matches any of the tags associated with the interface, the interface accepts the packet. If the tag in the packet does *not* match any of the tags associated with the interface, the interface rejects the packet.

◆ **Important**

You should use VLAN tagging only if you are running the 3-DNS Controller in bridge mode.

Configuration procedures

You configure tag-based access to VLANs using either the Configuration utility or the **bigpipe vlan** command. You can configure tag-based access either when you create a VLAN and add member interfaces to it, or by modifying the properties of an existing VLAN. In the latter case, you simply change the status of one or more member interfaces from untagged to tagged.

To create a VLAN that supports tag-based access using the Configuration utility

Creating a VLAN that supports tag-based access means creating the VLAN and then adding one or more tagged interfaces to it.

1. In the navigation pane, click **Network**.
The VLAN screen opens.
2. Click the **Add** button.
The Add VLAN screen opens.
3. On the Add VLAN screen, type the VLAN name.
4. In the **Tag** box, you can optionally specify a VLAN ID number. If you do not provide one, the 3-DNS Controller assigns a default number.
5. In the **Resources** box, specify any tagged interfaces by selecting the appropriate interface numbers from the **Interface Number** list and clicking **tagged >>**.
6. Configure the other VLAN options.
7. Click **Done**.

To configure tag-based access on an existing VLAN using the Configuration utility

Configuring tag-based access on an existing VLAN means changing the existing status of one or more member interfaces from **untagged** to **tagged**.

1. In the navigation pane, click **Network**.
The VLAN screen opens.
2. Click the VLAN name in the list.
The properties screen for that VLAN opens.
3. In the **Resources** box, move any untagged interfaces from the **Current Interfaces** list to the **Interface Number** list.
4. Specify any tagged interfaces by selecting the appropriate interface numbers from the **Interface Number** list and clicking **tagged >>**.
5. Click **Done**.

To create a VLAN that supports tag-based access from the command line

1. Type the **bigpipe vlan** command, specifying a VLAN name, the **tag** keyword, and a VLAN ID number. The following example creates the VLAN **external** with a VLAN ID of **1209**.

```
b vlan external tag 1209
```

2. Add the interfaces to the VLAN **external** as tagged interfaces. This is done by specifying the VLAN name, the **tagged** keyword, and the interfaces to be tagged. For example:

```
b vlan external interfaces add tagged 4.1 5.1 5.2
```

The effect of this command is to associate a tag with interfaces **4.1** and **5.1**, which in turn allows packets with that tag access to the **external** VLAN.

The above procedure adds multiple tagged interfaces to a single VLAN. However, you can also add a single tagged interface to multiple VLANs. This results in a single interface having more than one tag associated with it. For example, the following commands add the tagged interface **4.1** to the two VLANs **external** and **internal**:

```
b vlan external interfaces add tagged 4.1
```

```
b vlan internal interfaces add tagged 4.1
```

Setting up security for VLANs

You can lock down a VLAN to prevent direct connection to the 3-DNS Controller through that VLAN. You can override this lockdown for specific services by enabling the corresponding global variable for that service. For example:

```
b global open_ssh_port enable
```

To enable or disable port lockdown using the Configuration utility

1. In the navigation pane, click **Network**.
The VLAN screen opens.
2. Click the VLAN name in the list.
The properties screen for that VLAN opens.
3. To enable port lockdown, click a check in the **Port Lockdown** box.
To disable port lockdown, clear the **Port Lockdown** check box.
4. Click **Done**.

To enable or disable port lockdown from the command line

To enable port lockdown, type:

```
b vlan <vlan_name> port_lockdown enable
```

To disable port lockdown, type:

```
b vlan <vlan_name> port_lockdown disable
```

Setting fail-safe timeouts for VLANs

For redundant 3-DNS units, you can enable a failsafe mechanism that will fail over when loss of traffic is detected on a VLAN, and traffic is not restored during the fail-over timeout period for that VLAN. You can enable a fail-safe mechanism to attempt to generate traffic when half the timeout has elapsed. If the attempt is successful, the fail-over is stopped.

To set the fail-over timeout and arm the fail-safe using the Configuration utility

1. In the navigation pane, click **Network**.
The VLAN screen opens.
2. Click the VLAN name in the list.
The properties screen for that VLAN opens.
3. Check the **Arm Failsafe** box, and specify the timeout in seconds in the **Timeout** box.

To set the fail-over timeout and arm the fail-safe from the command line

Using the **vlan** command, you may set the timeout period and also arm or disarm the fail-safe.

To set the timeout, type:

```
b vlan <vlan_name> timeout <timeout_in_seconds>
```

To arm the fail-safe, type:

```
b vlan <vlan_name> failsafe arm
```

To disarm the fail-safe, type:

```
b vlan <vlan_name> failsafe disarm
```

Setting the MAC masquerade address

You can share the media access control (MAC) masquerade address between 3-DNS units in a redundant system. This option has the following advantages:

- Increased reliability and failover speed, especially in lossy networks
- Interoperability with switches that are slow to respond to the network changes
- Interoperability with switches that are configured to ignore network changes

◆ Note

*For sensible operation, you must set the MAC masquerade address to be the same on both the active and standby units. To do this, configure the shared MAC address manually, by editing the **bigip_base.conf** file on both units. Do not use the **bigpipe config sync** command.*

The MAC address for a VLAN is the MAC address of the first interface to be mapped to the VLAN, typically 4.1 for **external**, and 5.1 for **internal**. You can view the interfaces mapped to a VLAN using the following command:

```
b vlan show
```

You can view the MAC addresses for the interfaces on the 3-DNS Controller using the following command:

```
b interface show verbose
```

Use the following syntax to set the MAC masquerade address to be shared by both 3-DNS units in the redundant system.

```
b vlan <vlan_name> mac_masq <MAC_addr>
```

Find the MAC address on both the active and standby units, and pick one that is similar but unique. A safe technique for selecting the shared MAC address follows.

Suppose you want to set up **mac_masq** on the external interfaces. Using the **b interface show** command on the active and standby units, you note that their MAC addresses are:

```
Active: 3.1 = 0:0:0:ac:4c:a2
```

```
Standby: 3.1 = 0:0:0:ad:4d:f3
```

In order to avoid packet collisions, you now must choose a unique MAC address. The safest way to do this is to select one of the addresses, and convert the MAC address to a locally administered address using **0x40** for the first byte. (The **0x40** byte indicates the logical operator **OR**.)

In this example, either **40:0:0:ac:4c:a2** or **40:0:0:ad:4d:f3** would be a suitable shared MAC address to use on both 3-DNS units in the redundant system.

The shared MAC address is used only when the 3-DNS Controller is in active mode. When the unit is in standby mode, the original MAC address of the network card is used.

If you do not configure **mac_masq** on startup, or when transitioning from standby mode to active mode, the 3-DNS Controller sends gratuitous ARP requests to notify the default router and other machines on the local Ethernet segment that its MAC address has changed. See RFC 826 for more details on ARP.

◆ **Note**

*The MAC masquerade information is stored in the **bigip_base.conf** file.*

Configuring a self IP address

A self IP address is an IP address mapping to one or more VLANs and their associated interfaces on a 3-DNS Controller. You assign a self IP address to each interface on the unit as part of the initial configuration, and you also assign a floating (shared) alias for units in a redundant system. You can create additional self IP addresses for health checking, gateway failsafe, routing, or other purposes. You create additional self IP addresses using either the Configuration utility or using the **self** command in the **bigpipe** utility. (See the *3-DNS Reference Guide*, Appendix B, *bigpipe Command Reference*, for more information on the **self** command.)

To add a self IP address to a VLAN using the Configuration utility

1. In the navigation pane, click **Network**.
The VLANs screen opens.
2. Click the Self IP Addresses tab.

3. Click the **Add** button.
4. In the **IP Address** box, type the self IP address to be assigned.
5. In the **Netmask** box, type an optional netmask.
6. In the **Broadcast** box, type an optional broadcast address.
7. If you want to configure the self IP address as a floating address, check the **Floating** box.
8. If you want to enable the address for SNAT auto-mapping, check the **SNAT Automap** box.
9. In the **VLAN** box, type the name of the VLAN to which you want to assign the self IP address.
10. Click **Done**.

To add a self IP address to a VLAN from the command line

Use the following syntax:

```
b self <addr> vlan <vlan_name> [ netmask <ip_mask> ] [ broadcast <broadcast_addr> ] [unit <id>]
```

You can add any number of additional self IP addresses to a VLAN to create aliases. For example:

```
b self 11.11.11.4 vlan external
b self 11.11.11.5 vlan external
b self 11.11.11.6 vlan external
b self 11.11.11.7 vlan external
```

Also, any one self IP address may have **floating** enabled to create a *floating alias* that is shared by both units of a redundant system:

```
b self 11.11.11.8 floating enable
```

Assigning a self IP address to an interface automatically maps it to the VLAN of which it is a member. Assigning a self IP address to an interface not mapped to an untagged VLAN produces an error message.



5

Essential Configuration Tasks

- Reviewing the configuration tasks
- Setting up a basic configuration
- Setting up a data center
- Setting up servers
- Working with sync groups
- Overview of auto-configuration
- Configuring global variables

Reviewing the configuration tasks

Once you have completed the Setup utility, you set up the network and load balancing aspects of the 3-DNS Controller. The 3-DNS Controller has three essential configuration tasks that all users must complete, regardless of the chosen load balancing solution.

- ◆ Configure the physical aspects of your load balancing network, which includes the following:
 - Data centers
 - Data center servers and their virtual servers
 - Communications between the 3-DNS Controller and other servers
 - 3-DNS synchronization (if you have more than one 3-DNS Controller in your network)
- ◆ Configure the logical aspects of your load balancing network, including wide IPs and pools
- ◆ Configure the global load balancing modes and global variables

Setting up a basic configuration

Each 3-DNS Controller in the network setup must have information regarding which data center houses specific servers, and with which other 3-DNS Controllers it can share configuration and load balancing information. A basic network setup includes data centers, servers, and one sync group. Once you have the basic network components configured on your 3-DNS Controller, you can set up the wide IPs you need for managing your load balancing. We recommend that you review the load balancing solutions in the remaining chapters of this guide before you configure the wide IPs.

The following sections describe the various elements of a basic network:

- ◆ **Data centers**

Data centers are the top level of your network setup. We recommend that you configure one data center for each physical location in your global network. The data center element of your configuration defines the servers (3-DNS Controllers, BIG-IP systems, EDGE-FX systems, hosts, and routers) that reside at that location.

A data center can contain any type of server. For example, in Figure 5.1 on page 5-4, the Tokyo data center contains a 3-DNS Controller and a host, while the New York and Los Angeles data centers contain 3-DNS Controllers and BIG-IP systems.

For information about configuring data centers, see *Setting up a data center*, on page 5-3.

- ◆ **Servers**

The data center servers that you define in the network setup include 3-DNS Controllers, BIG-IP systems, EDGE-FX systems, hosts, and routers. You define the 3-DNS Controllers that manage load balancing to the BIG-IP systems, EDGE-FX systems, and hosts, and you also define the virtual servers that are managed by the servers. Virtual servers are the ultimate destination for connection requests.

For information about configuring servers, see *Setting up servers*, on page 5-5.

- ◆ **Sync groups**

Sync groups contain only 3-DNS Controllers. When setting up a sync group, you define which 3-DNS Controllers have the same configuration. In most cases, you should define all 3-DNS Controllers as part of the same sync group.

For information about configuring sync groups, see *Working with sync groups*, on page 5-13.

- ◆ **Wide IPs**

After you define virtual servers for your BIG-IP systems, EDGE-FX systems, and hosts, you need to define wide IPs to specify how connections are distributed among the virtual servers. A *wide IP* maps a

domain name to a pool of virtual servers, and it specifies the load balancing modes that the 3-DNS Controller uses to choose a virtual server from the pool.

When a local DNS server requests a connection to a specific domain name, the wide IP definition specifies which virtual servers are eligible to answer the request, and which load balancing modes to use in choosing a virtual server to resolve the request.

For information about configuring wide IPs and choosing load balancing modes, please refer to Chapter 2, *Load Balancing*, in the **3-DNS Reference Guide**.

◆ **Global variables**

You can configure global variables that apply to all servers and wide IPs in your network. However, the default values of the global variables work well for most situations, so configuring global variables is optional.

For information about configuring global variables, see *Configuring global variables*, on page 5-17.

Setting up a data center

The first step in configuring your 3-DNS network is to create data centers. A **data center** defines the group of 3-DNS Controllers, BIG-IP systems, EDGE-FX systems, and host systems that reside in a single physical location. For each data center that contains a 3-DNS Controller or a BIG-IP system, you can also define a router. Figure 5.1 on page 5-4 shows an example of a data center.

The advantage of grouping all systems from a single physical location into one data center in the configuration is to allow path information collected by one server to be shared with all other servers in the data center. The 3-DNS Controller uses the **big3d** agent to collect path and metrics information about the other servers, and their virtual servers, in the data center. The 3-DNS Controller then applies path metrics results to all the virtual servers in the data center when making load balancing decisions.

◆ **Note**

You must configure at least one data center before you can add servers to the 3-DNS configuration.

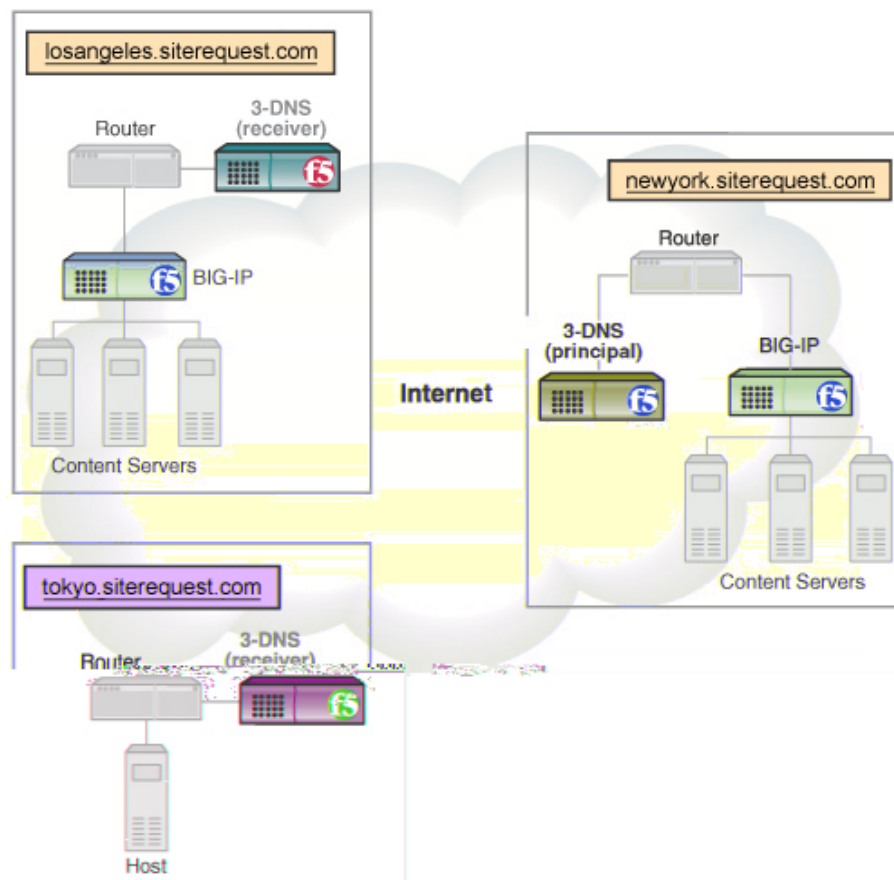

Figure 5.1 Example of a multiple data center setup

When you add servers to the network setup, you assign the servers to the appropriate data centers.

To configure a data center using the Configuration utility

1. In the navigation pane, click **Data Centers**.
2. On the toolbar, click **Add Data Center**.
The Add New Data Center screen opens.
3. Add the new data center settings. For help on defining data centers, click **Help** on the toolbar.
The data center is added to your configuration.
4. Repeat this process for each data center in your network.

◆ Note

*To configure a data center from the command line, refer to Appendix A, **3-DNS Configuration File**, in the **3-DNS Reference Guide**.*

Setting up servers

There are five types of servers you can configure on a 3-DNS Controller: 3-DNS Controllers, BIG-IP systems, EDGE-FX systems, hosts, and routers. At the minimum, your network includes one 3-DNS Controller, and at least one server (BIG-IP system, EDGE-FX system, or host) that it manages.

This section describes how to set up each server type (3-DNS Controller, BIG-IP system, EDGE-FX system, host, and router) that makes up your network. The setup procedures here assume that the servers are up and running in the network, and that they already have virtual servers defined (if the server manages virtual servers). Note that 3-DNS Controllers and routers do not manage virtual servers.

◆ Important

If you are adding a BIG-IP Link Controller to the 3-DNS configuration, you add the Link Controller as a BIG-IP system. If you want the 3-DNS Controller to be aware of and manage the links on the Link Controller, then you add the Link Controller as a 3-DNS system, also.

Defining 3-DNS Controllers

The purpose of defining a 3-DNS Controller in the configuration is to establish in which data center the 3-DNS Controller resides and, if necessary, to change **big3d** agent settings. Before you add other 3-DNS Controllers to the configuration, you should add the 3-DNS Controller you are configuring to its own configuration. By adding any additional 3-DNS Controllers to the configuration, you make those 3-DNS Controllers available so that you can add them to a sync group.

◆ Note

*Please review Chapter 10, **Adding a 3-DNS Controller to an Existing Network**, if you are configuring more than one 3-DNS Controller in your network.*

To define a 3-DNS Controller using the Configuration utility

1. In the navigation pane, expand the **Servers** item, then click **3-DNS**.
2. On the toolbar, click **Add 3-DNS**.
The Add New 3-DNS screen opens.

Chapter 5

To add virtual servers using the Configuration utility

1. In the navigation pane, expand the **Servers** item, and then click **BIG-IP**.
2. In the table, find the BIG-IP system that you just added.
3. Click the entry in its **BIG-IP Virtual Servers** column.
4. On the toolbar, click **Add Virtual Server**.
The Add Virtual Server to BIG-IP screen opens.
5. Add the new virtual server settings. For help on adding virtual servers, click **Help** on the toolbar.

Repeat this process for each virtual server you want to add to this BIG-IP system.

◆ Note

*For details on how to configure a BIG-IP system from the command line, refer to Appendix A, **3-DNS Configuration File**, in the **3-DNS Reference Guide**.*

Defining a BIG-IP system with the 3-DNS module

In the 3-DNS configuration, you treat the BIG-IP system and the 3-DNS Controller module as if they were separate devices. You can add the two server types either by using the Configuration utility or by editing the **wideip.conf** file. The following instructions describe how to add a BIG-IP system with the 3-DNS Controller module, with the name **combo.siterequest.net** and the IP address **192.168.100.100**, to the configuration.

Before you define a BIG-IP system with the 3-DNS Controller module in the 3-DNS configuration, you should have the following information:

- The name and IP address of the BIG-IP system
- The name and IP address of the 3-DNS Controller

To add a BIG-IP system with the 3-DNS Controller module using the Configuration utility

1. In the navigation pane, expand the **Servers** item, and then click **BIG-IP**.
The BIG-IP List screen opens.
2. On the toolbar, click **Add BIG-IP**.
The Add BIG-IP screen opens.
3. In the **BIG-IP Name** box, type **combo.siterequest.net**.
4. In the **BIG-IP IP Address** box, type **192.168.100.100**.

5. Add the rest of the settings as needed.

Note: When you have finished defining the BIG-IP system, you can add the 3-DNS Controller module to the configuration.

6. In the navigation pane, expand the **Servers** item, and then click **3-DNS**.
The 3-DNS List screen opens.
7. On the toolbar, click **Add 3-DNS**.
The Add 3-DNS screen opens.
8. In the **3-DNS Name** box, type **combo.siterequest.net**.
9. In the **3-DNS IP Address** box, type **192.168.100.100**.
10. Add the rest of the settings as needed.

◆ **Note**

*For details on how to configure a BIG-IP system with the 3-DNS Controller module from the command line, refer to Appendix A, **3-DNS Configuration File**, in the **3-DNS Reference Guide**.*

Defining a router

Routers do not manage virtual servers, rather they manage the links to the Internet for your network. Before you define a router in the 3-DNS configuration, you should have the following information:

- The name of the router
- The IP address of the router (this is the gateway IP address)
- The IP addresses of the links that the router manages

◆ **Note**

If you have a Link Controller or BIG-IP system in your network, the auto-configuration process adds the routers to the configuration for you. Note, however, that for BIG-IP systems, auto-configuration adds only one router per data center. Use the following procedure only if you have auto-configuration turned off.

To define a router using the Configuration utility

1. In the navigation pane, expand the **Servers** item, then click **Routers**.
2. On the toolbar, click **Add Router**.
The Add New Router screen opens.

3. Add the new router settings. For help on defining a router, click **Help** on the toolbar.

◆ **Note**

*For details on how to configure a router from the command line, refer to Appendix A, **3-DNS Configuration File**, in the **3-DNS Reference Guide**.*

Defining EDGE-FX systems

An EDGE-FX system can be either an EDGE-FX Cache, or a GLOBAL-SITE Controller. Before you define any EDGE-FX systems, you should have the following information:

- The IP address of the system itself
- The IP address and service name or port number of each virtual server managed by an EDGE-FX Cache

◆ **Important**

*Auto-configuration automatically collects the virtual server configuration information for any EDGE-FX systems you may have in your network. For more information about auto-configuration, see **Overview of auto-configuration**, on page 5-15.*

To define an EDGE-FX system using the Configuration utility

1. In the navigation pane, expand the **Servers** item, then click **EDGE-FX**.
2. On the toolbar, click **Add EDGE-FX**.
The Add New EDGE-FX screen opens.
3. Add the new EDGE-FX system settings. Note that if you want the 3-DNS Controller to discover the EDGE-FX system's virtual servers, select **ON** for the **Discovery** setting. (For help on defining EDGE-FX systems, click **Help** on the toolbar.)
4. Click **Add** when you have finished configuring the initial settings for the EDGE-FX system.
The controller adds the EDGE-FX system information to the configuration.

◆ **Important**

*Auto-configuration collects the virtual server information for any EDGE-FX systems you have in your network, if you turn on **Discovery** when you add the EDGE-FX system to the configuration. For more information about auto-configuration, see **Overview of auto-configuration**, on page 5-15.*

If you do not turn on Discovery when you add the EDGE-FX system to the configuration, then use the following procedure to add virtual servers to the EDGE-FX definition in the configuration.

To add virtual servers using the Configuration utility

1. In the navigation pane, click **Servers**, then click **EDGE-FX**.
2. In the table, find the EDGE-FX system that you just added.
3. Click the entry in its EDGE-FX Virtual Servers column.
4. On the toolbar, click **Add Virtual Server**.
The Add Virtual Server to EDGE-FX screen opens.
5. Add the new virtual server settings. For help on adding virtual servers, click **Help** on the toolbar.

Repeat this process for each virtual server you want to add. Note that GLOBAL-SITE Controllers do not manage virtual servers.

◆ **Note**

*For details on how to configure an EDGE-FX system from the command line, refer to Appendix A, **3-DNS Configuration File**, in the **3-DNS Reference Guide**.*

Defining host servers

A *host* is an individual network server or server array controller other than a 3-DNS Controller, BIG-IP system, EDGE-FX Cache, GLOBAL-SITE Controller, or router. Before configuring a host, you should have the following information:

◆ **Address information**

The IP address and service name or port number of each virtual server to be managed by the host.

◆ **SNMP information for host probing**

To implement host probing and to collect performance metrics, you must specify SNMP agent settings after you define the host server. The settings you specify include the type and version of SNMP agent that runs on the host, the community string, and the number of communication attempts that you want the **big3d** agent to make while gathering host metrics. SNMP agent settings for hosts are described in *Configuring host SNMP settings*, on page 5-12.

◆ **Note**

*To fully configure host probing, you must configure the SNMP agent settings in the host definition as previously described, set up the **big3d** agents to run SNMP factories, and configure the SNMP agents on the hosts themselves. For details, please refer to Chapter 5, **Probing and Metrics Collection**, in the **3-DNS Reference Guide**.*

◆ Important

*Auto-configuration automatically collects the virtual server configuration information for any load-balancing hosts you may have in your network (with the exception of Cisco® LocalDirectors). For more information about auto-configuration, see **Overview of auto-configuration**, on page 5-15.*

To define a host using the Configuration utility

1. In the navigation pane, expand the **Servers** item, and then click **Host**.
2. On the toolbar, click **Add Host**.
The Add New Host screen opens
3. Add the new host settings. Note that if you want the 3-DNS Controller to discover the host's virtual servers, select **ON** for the **Discovery** setting. (For help on defining hosts, click **Help** on the toolbar.)
4. Click **Add** when you have finished configuring the initial settings for the host.
The controller adds the host information to the configuration.

◆ Important

*Auto-configuration collects the virtual server information for any host systems you have in your network, if you turn on **Discovery** when you add the host to the configuration. For more information about auto-configuration, see **Overview of auto-configuration**, on page 5-15.*

If you do not turn on **Discovery** (step 3, in previous procedure) when you add the host to the configuration, then use the following procedure to add virtual servers to the host definition.

To add more virtual servers using the Configuration utility

1. In the navigation pane, click **Host**.
 2. In the table, find the host that you just added, and click the entry in its **Host Virtual Servers** column.
 3. On the toolbar, click **Add Host Virtual Server**.
The Add Virtual Server to Host screen opens.
 4. Add the new virtual server settings. For help on adding virtual servers, click **Help** on the toolbar.
- Repeat this process for each virtual server you want to add to this host.

◆ Note

*For details on how to configure a host from the command line, refer to **Appendix A, 3-DNS Configuration File**, in the **3-DNS Reference Guide**.*

Configuring host SNMP settings

After defining a host server, you need to configure its SNMP settings if you want to use SNMP host probing. Remember that you must first set up at least one SNMP probing factory on any 3-DNS Controller, BIG-IP system, EDGE-FX Cache, or GLOBAL-SITE Controller that runs the **big3d** agent and is in the same data center as the host.

The SNMP prober collects some or all of the following information from hosts.

- Memory utilization
- CPU utilization
- Disk space utilization
- Packet rate (packets per second)
- Throughput rate (kilobytes per second)
- Current connections

The 3-DNS Controller uses this performance information for dynamic load balancing modes, such as Packet Rate, Quality of Service, and Kilobytes/Second.

Table 5.1 shows the host SNMP agents supported by the 3-DNS Controller.

SNMP Agent	Description
Generic	A generic SNMP agent is an SNMP agent that collects metrics provided by object identifiers (OIDs) as specified in the RFC 1213 document.
UCD	This free SNMP agent is provided by the University of California at Davis. It is available on the web at http://net-snmp.sourceforge.net
Solstice	This SNMP agent is a product of Sun [®] Microsystems.
NTServ	This SNMP matrix agent is distributed with Microsoft [®] Windows NT [®] Server 4.0.
Win2KServ	This SNMP matrix agent is distributed with Microsoft Windows 2000 Server.
Cisco LDV2	This SNMP agent is distributed with the Cisco [®] LocalDirector, version 2.X.
Cisco LDV3	This SNMP agent is distributed with the Cisco LocalDirector, version 3.X.
ArrowPoint	This SNMP agent is distributed with the Cisco/ArrowPoint CSS series.
Alteon	This SNMP agent is distributed with the Alteon [®] WebSystems ACEdirector.
Foundry	This SNMP agent is distributed with the Foundry [®] ServerIron.
CacheFlow	This SNMP agent is distributed with the CacheFlow [®] appliances.

Table 5.1 Supported SNMP agents

Viewing host performance metrics

The Configuration utility displays the host metrics in the Host Statistics screen. The 3-DNS Controller bases the advanced load balancing decisions on packet rate, kilobytes per second, and current connections metrics, but the Host Statistics screen displays the other metrics as well, for information purposes.

Reviewing SNMP configuration issues

The SNMP probing feature requires that each host run an SNMP agent, and that the hosts and the **big3d** agents in the data centers have open network communication. Certain firewall configurations block SNMP communications, and you may need to verify that the firewalls in your network allow SNMP traffic to pass through.

In addition to properly configuring the SNMP agents on the hosts themselves, you need to specify SNMP host probing settings in two places in the 3-DNS configuration. First, when you define a 3-DNS Controller or BIG-IP system, you set the **big3d** agent to run at least one SNMP factory. Second, when you define the host servers, you configure specific SNMP agent settings for each host. For example, you need to specify the type of agent running on the host as well as the community string that allows access to the SNMP agent. Last, you configure the SNMP agent on the host itself. We recommend that you use the documentation originally provided with host to configure the SNMP agent.

◆ **Note**

*For more information about working with the big3d agent and SNMP, refer to Chapter 5, **Probing and Metrics Collection**, in the **3-DNS Reference Guide**.*

Working with sync groups

A **sync group** defines a group of 3-DNS Controllers that synchronize their configuration settings, metrics data, and zone files (optional). A sync group contains a principal system and one or more receiver systems. The **principal** system is the 3-DNS Controller from which the **receiver** systems obtain their metrics and server statistics information. You configure a sync group from the principal 3-DNS Controller. First list the IP address of the principal itself. Then list the receiver 3-DNS Controllers in the order that they should become principals if previously listed 3-DNS Controllers fail.

Configuring sync groups

The following procedures describe how to configure sync groups.

To define a sync group using the Configuration utility

1. In the navigation pane, click **3-DNS Sync**.
The System - Add a New Sync Group screen opens.
2. In the **New Sync Group Name** box, type the name of the new sync group and click **Add**.
The Add a 3-DNS to a Sync Group screen opens.
3. From the list of 3-DNS Controllers, first select the 3-DNS Controller that you want to be the principal system. Then check the box next to each 3-DNS Controller that you want to add to the sync group.
4. Click **Add**.

◆ Note

*For details on how to configure a sync group from the command line, refer to Appendix A, **3-DNS Configuration File**, in the **3-DNS Reference Guide**.*

Setting the time tolerance value

The time tolerance value is a global variable that defines the number of seconds that one 3-DNS Controller's time setting is allowed to be out of sync with another 3-DNS Controller's time setting. We recommend that you leave the time tolerance variable at the default setting of **10**.

To check the value for the time tolerance setting using the Configuration utility

1. In the navigation pane, click **System**.
The System - General screen opens.
2. On the toolbar, click **Timers and Task Intervals**.
3. Note the value in the **3-DNS Sync Time Tolerance** box, and change it if necessary.
4. If you change this setting, click **Update** to save it. For more information about the settings on this screen, click **Help** on the toolbar.

To check the value for the time tolerance setting in the configuration file

1. To ensure that the configuration files contain the same information as the memory cache, type the following command:

```
3ndc dumpdb
```
2. Open the **wideip.conf** file in a text editor (either **vi** or **pico**).
3. Search for **time_tolerance**. If the **time_tolerance** sub-statement is not in the configuration file, the default (**10**) is used.

4. Save and close the file.
5. Commit the changes to the configuration by typing:

```
3ndc reload
```

Overview of auto-configuration

The 3-DNS Controller automatically retrieves configuration details from BIG-IP systems, hosts, and other 3-DNS Controllers that you add to the 3-DNS configuration. This process is known as *auto-configuration*. Auto-configuration queries BIG-IP systems for their configuration information, including self IP addresses and virtual servers. Auto-configuration can also gather configuration information for host systems that have SNMP enabled. Using auto-configuration eliminates the repetitive tasks of entering configuration information both on the BIG-IP systems and hosts, and on the 3-DNS Controller, thus dramatically reducing administrative overhead.

Auto-configuration continually monitors the configurations for changes. When you add or remove an object from a BIG-IP system, 3-DNS Controller, or host, the change displays almost immediately in the 3-DNS configuration. The 3-DNS Controller also synchronizes the changes among the sync group members.

Once the 3-DNS Controller has retrieved the initial configuration, you modify the auto-configuration settings for each server type using the Configuration utility. Auto-configuration has three settings:

- ◆ **ON**
When the **Discovery** setting is set to **ON**, the 3-DNS Controller polls the BIG-IP systems and host systems in the network every 30 seconds to update the configuration information for those systems. Any changes, additions, or deletions are then made to the controller's configuration.
- ◆ **ON/NO DELETE**
When the **Discovery** setting is set to **ON/NO DELETE**, the 3-DNS Controller polls the BIG-IP system and host systems in the network every 30 seconds to update the configuration information for those systems. Any changes or additions are then made to the controller's configuration. Any deletions in the configuration are ignored. This setting is helpful if you want to take systems in and out of service without modifying the 3-DNS configuration.
- ◆ **OFF**
When the **Discovery** setting is set to **OFF**, the 3-DNS Controller does not collect any configuration information from the BIG-IP system and

host systems in the network. Instead, you must make all changes to the configuration either by using the Configuration utility, or by editing the **wideip.conf** file. Note that this is the default setting.

◆ **Note**

*In the Configuration utility, auto-configuration is labeled **Discovery**.*

To modify the auto-configuration setting for a BIG-IP system using the Configuration utility

1. In the navigation pane, expand the **Servers** item, and then click **BIG-IP**.
The BIG-IP List screen opens.
2. Click the name of the BIG-IP system for which you want to modify the auto-configuration setting.
The Modify BIG-IP screen opens.
3. In the **Discovery** box, select one of the following settings: **ON**, **ON/NO DELETE**, or **OFF**.
4. Click **Update**.
The configuration updates with the new setting.

To modify the auto-configuration setting for a host using the Configuration utility

1. In the navigation pane, expand the **Servers** item, and then click **Host**.
The Host List screen opens.
2. Click the name of the host for which you want to modify the auto-configuration setting.
The Modify Host screen opens.
3. In the **Discovery** box, select one of the following settings: **ON**, **ON/NO DELETE**, or **OFF**.
4. Click **Update**.
The configuration updates with the new setting.

To modify the auto-configuration setting for a 3-DNS Controller using the Configuration utility

1. In the navigation pane, expand the **Servers** item, and then click **3-DNS**.
The 3-DNS List screen opens.
2. Click the name of the host for which you want to modify the auto-configuration setting.
The Modify 3-DNS screen opens.

3. In the **Discovery** box, select one of the following settings: **ON**, **ON/NO DELETE**, or **OFF**.
4. Click **Update**.
The configuration updates with the new setting.

Configuring global variables

The global variables determine the default settings for iQuery messages, synchronization, encryption, and default load balancing parameters. The default values for the global variables are sufficient for most load balancing situations.

To configure global parameters using the Configuration utility

1. In the navigation pane, click **System**.
The System - General screen opens. Note that global parameters are grouped into several categories on this screen. Each category has its own toolbar item, and online help is available for each parameter.
2. Make general global changes at the System - General screen or, to make changes to global parameters in other categories, click the appropriate toolbar item.
3. Add the new global settings. For help on configuring the global settings, click **Help** on the toolbar.

The new global parameters are added to your configuration.



6

Configuring a Globally-Distributed Network

- Understanding a globally-distributed network
- Using Topology load balancing
- Setting up a globally-distributed network configuration
- Additional configuration settings and tools

Understanding a globally-distributed network

When you are familiar with your traffic patterns and are expanding into a global marketplace, you can use the 3-DNS Controller to distribute requests in an efficient and seamless manner using Topology load balancing. When you use Topology load balancing, the 3-DNS Controller compares the location information derived from the DNS query message to the topology records in the topology statement. The system then distributes the request according to the topology record that best matches the location information.

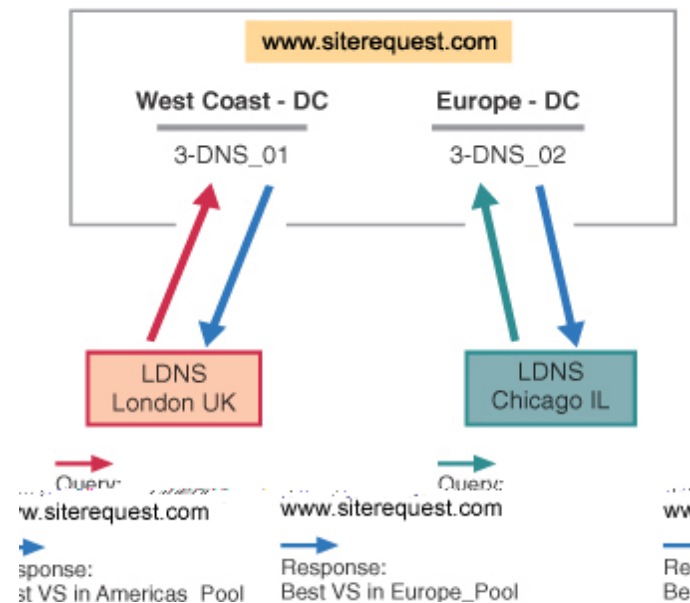

Figure 6.1 Topology load balancing in a globally-distributed network

Using Topology load balancing

The Topology load balancing mode is optimal for organizations that have data centers in more than one country or on more than one continent. The 3-DNS Controller enables topology-based load balancing by resolving DNS requests to the geographically closest server. The traditional topology load balancing mode, which provides basic topology mapping functionality, uses IP subnets of virtual servers and known LDNS servers. This can result in a very large list of IP subnets to manage when you want to map a specific geographic region.

To simplify topology load balancing, the 3-DNS Controller contains a classifier that maps IP addresses to geographic locations. With this classifier, the 3-DNS Controller resolves DNS requests to the geographically closest LDNS server at either the country or the continent level. The system then load balances the request to virtual servers in IP subnets, wide IP pools, or data centers.

You can set up Topology load balancing either between wide IP pools or within a wide IP pool. For the example in Figure 6.1, we configure Topology load balancing between wide IP pools.

Setting up a globally-distributed network configuration

By going through the following setup tasks, you can configure the 3-DNS Controller to process requests, using Topology, in a globally-distributed network. This configuration is based on the following assumptions:

- You have more than one data center.
- You have a 3-DNS Controller in each data center.
- You have BIG-IP systems, or other load balancing hosts, in the data centers.
- You want to load balance requests to the geographically closest virtual server.

If you use a CDN for some or all of your content delivery, please refer to Chapter 7, *Configuring a Content Delivery Network*, to set up this configuration.

The following sections describe, in order, the specific configuration tasks you perform to set up a globally-distributed network. Please review the tasks before you actually perform them, so that you are familiar with the process.

Adding data centers to the globally-distributed network configuration

The first task you perform is to add your data centers to the 3-DNS configuration.

To add data centers using the Configuration utility

1. In the navigation pane, click **Data Centers**.
The Data Centers screen opens.
2. Click **Add Data Center** on the toolbar.
The Add Data Centers screen opens.
3. Add your data center information. For information and help on the specific settings on this screen, click **Help** on the toolbar.
4. Repeat the previous steps to add all of your data centers to the configuration.

Configuration notes

*For the globally-distributed network configuration shown in Figure 6.1, on page 6-1, we have added two data centers labeled **West Coast - DC** and **Europe - DC**.*

Adding 3-DNS Controllers to the globally-distributed network configuration

Once you have added all of your data centers to the 3-DNS configuration, you are ready to notify the 3-DNS Controller that you are configuring about the 3-DNS Controllers in your network, including the 3-DNS Controller you are configuring.

◆ Note

*Please note that when you are working with more than one 3-DNS Controller, you create your entire configuration on one system and then add the second system using the **3dns_add** script. The **3dns_add** script copies the entire configuration from the first (or existing) system onto the second (new) system, and synchronizes all of the settings. For details on configuring additional 3-DNS Controllers in existing networks, using the **3dns_add** script, see Chapter 10, **Adding a 3-DNS Controller to an Existing Network**.*

To add 3-DNS Controllers using the Configuration utility

1. In the navigation pane, expand the **Servers** item, then click **3-DNS**.
The 3-DNS List screen opens.

2. Click **Add 3-DNS** on the toolbar.
The Add New 3-DNS screen opens.

For information and help on the specific settings on any screen in the Configuration utility, click **Help** on the toolbar.
3. Add the 3-DNS Controller information.
4. Repeat the previous steps to add any additional 3-DNS Controllers to the configuration.

Configuration notes

*For the globally-distributed network configuration shown in Figure 6.1, on page 6-1, we have a 3-DNS Controller in each data center, **West Coast - DC** and **Europe - DC**. The system we are configuring is labeled **3-DNS_01**, and is in the **West Coast - DC** data center. The additional system is in the **Europe - DC** data center, and is labeled **3-DNS_02**.*

Adding BIG-IP systems to the globally-distributed network configuration

Now you are ready to let the 3-DNS Controller know about any BIG-IP systems, or other servers, that you have in your network. Remember that the 3-DNS Controller load balances requests to the virtual servers managed by the BIG-IP systems, EDGE-FX systems, or host servers in your network. In this example configuration, we set up BIG-IP systems. For information on adding EDGE-FX systems or host servers to your network, please refer to *Setting up servers*, on page 5-6.

The following steps outline how to add BIG-IP systems to your configuration.

To add BIG-IP systems using the Configuration utility

1. In the navigation pane, expand the **Servers** item, then click **BIG-IP**.
The BIG-IP List screen opens.
2. Click **Add BIG-IP** on the toolbar.
The Add New BIG-IP screen opens.
3. Enter the BIG-IP system information, and click **Next**.
4. In the Data Centers screen, select the data center where the BIG-IP system is located, and click **Next**.
5. In the Configure Virtual Server screen, specify the information for the first virtual server managed by the BIG-IP system, and click **Finish**.
6. To add more virtual servers to your configuration, click **Add Virtual Server** on the toolbar.

7. Once you have configured your first BIG-IP system, you can repeat the previous steps to add all of the additional BIG-IP systems to the 3-DNS configuration.

◆ Tip

*For information and help on the specific settings on any screen in the Configuration utility, click **Help** on the toolbar.*

Adding wide IPs to the globally-distributed network configuration

Once you have added all the physical elements to your 3-DNS configuration, you can begin configuring wide IPs and pools for load balancing. Before you start adding wide IPs, verify that you have configured all the virtual servers you need for load balancing. In order to optimize the Topology load balancing mode, you need to properly configure the wide IPs and pools, as follows.

To add a wide IP and pool using the Configuration utility

1. In the navigation pane, click **Wide IPs**.
The Wide IP List screen opens.
2. Click **Add Wide IP** on the toolbar.
The Add a New Wide IP screen opens.
3. Specify the wide IP address, name, and port information.
4. For the **Pool LB Mode**, select **Topology**, and click **Next**.
The Configure Load Balancing for New Pool screen opens.
5. Specify the pool name and click **Next**.
The Select Virtual Servers screen opens.
6. In the Select Virtual Servers screen, check the virtual servers among which you want the 3-DNS Controller to load balance DNS requests, and click **Finish**.
The 3-DNS Controller adds the wide IP and settings to the configuration.
7. If you want to create additional pools for load balancing, click the name of the wide IP you just created in the Wide IPs List screen. When the Modify Wide IP screen opens, click **Add Pool** on the toolbar.
8. Repeat the previous procedure to add as many wide IPs and pools as are required for your network.

◆ Tip

*For information and help on the specific settings on any screen in the Configuration utility, click **Help** on the toolbar.*

Configuration notes

For the globally-distributed network configuration shown in Figure 6.1, on page 6-1, we have set up one wide IP, labeled **www.siterequest.com**, and we added two pools to the wide IP, **americas_pool** and **europa_pool**. When you configure the topology records, as explained in the next section, we designate these two pools to process the load balancing requests based on the geographic location of the local DNS server or client making the request.

Configuring topology records for the globally-distributed network configuration

You must configure topology records before the 3-DNS Controller can use the Topology load balancing mode. The Topology load balancing mode distributes connections after evaluating and scoring the topology records in the topology statement. If you have no topology records in the topology statement, or if the scores returned for two or more records are equal, the 3-DNS Controller load balances the virtual servers using the Random load balancing mode.

The following procedure explains how to configure topology records in the Configuration utility. For more information on how the 3-DNS Controller uses the topology records, and how to configure topology in the **wideip.conf** file, please review Chapter 3, *Topology*, in the **3-DNS Reference Guide**.

To configure topology records using the Configuration utility

1. In the navigation pane, click **Topology**.
The Manage Topology Records screen opens.
2. Specify the settings for the topology records.
3. Click **Add**.

◆ Tip

For information and help on the specific settings on any screen in the Configuration utility, click **Help** on the toolbar.

For the globally-distributed network configuration shown in Figure 6.1, on page 6-1, we added topology records, as shown in Figure 6.2.

//server	ldns	score
pool.americas_pool	cont.North America	100
pool.europa_pool	!cont.North America	100

Figure 6.2 Example of a topology statement

With this topology statement, in our example configuration, queries to resolve **www.siterequest.com** from local DNS servers somewhere in North America get responses from virtual servers in the pool **americas_pool**. All other queries to resolve **www.siterequest.com** get responses from virtual servers in the pool **europa_pool**.

Additional configuration settings and tools

The following optional settings and tools can help you refine your load balancing configuration.

Setting limits thresholds

When you set limits thresholds for availability, the 3-DNS Controller can detect when a managed server or virtual server is low on system resources, and can redirect the traffic to another virtual server. Setting limits helps eliminate any negative impact on a virtual server's performance of service tasks that may be time critical, require high bandwidth, or put high demand on system resources. The system resources for which you can set limits are:

- CPU
- Disk
- Memory
- Packet rate
- Kilobytes per second (throughput rate)
- Current connections

To set limits thresholds for BIG-IP systems

1. In the navigation pane, expand the **Servers** item, and click **BIG-IP**.
2. In the Limits Settings column of the BIG-IP system for which you want to set limit thresholds, click the Configure Limits button . The Modify Server Limits Settings screen opens.
3. Check the metrics for which you want to set limits, and type values based on your network resources. For more information and help on this screen, click **Help** on the toolbar.

You can also set limits thresholds on virtual server resources. Please note that if a server meets or exceeds its limits settings, both the server and the virtual servers it manages are marked as unavailable for load balancing. You can quickly review the availability of any of your servers or virtual servers in the Statistics screens in the Configuration utility.

Other resources

In addition to setting limits, the 3-DNS Controller provides the following resources to help you maintain your configuration and monitor system performance.

Monitoring system performance

The Statistics screens in the Configuration utility provide a great deal of information about the 3-DNS Control56.2.349Fabo y can molnito



7

Configuring a Content Delivery Network

- Introducing the content delivery network
- Deciding to use a CDN provider
- Setting up a CDN provider configuration
- Ensuring resource availability
- Monitoring the configuration

Introducing the content delivery network

A *content delivery network* (CDN) is a network of clusters that includes devices designed and configured to maximize the speed at which a content provider's content is delivered. The purpose and goal of a content delivery network is to cache content closer, in Internet terms, to the user than the origin site is. Using a CDN to deliver content greatly reduces wide area network (WAN) latency so the content gets to the user more quickly, and the origin site servers are not overloaded and slowed by requests for content. The fundamental WAN traffic distribution mechanism in all CDNs that we know about is DNS.

Using the 3-DNS Controller in a CDN

The following features make the 3-DNS Controller a logical choice for the wide-area traffic management in a CDN.

- ◆ **CDN switching**

CDN switching is the functionality of the 3-DNS Controller that allows a user to delegate global traffic to a third-party network. The two features of the 3-DNS Controller that make CDN switching possible are:

- **Geographic redirection**

The 3-DNS Controller uses the Topology load balancing mode to redirect DNS requests based on location information derived from the DNS query message. You can set up wide IPs so that the 3-DNS Controller delegates DNS queries either to a data center, by responding with **A** records, or to a CDN provider, by responding with a **CNAME** record.

- **CDN providers**

We have partnered with several CDN providers to facilitate usage of CDNs. To take advantage of these content delivery partnerships, you can designate a pool type **CNAME** on the 3-DNS Controller so that the 3-DNS Controller redirects requests to a CDN provider's name servers rather than to a grouping of virtual servers. For a list of our partner CDN providers, click **CDN Providers** on the 3-DNS Controller home screen.

- ◆ **Resource monitoring, limits, and thresholds**

The 3-DNS Controller has sophisticated monitoring screens so you can quickly analyze the performance and availability of your network resources. You can also set limits on physical and throughput resources to ensure that your content is always available and none of your resources are overtaxed.

Reviewing a sample CDN configuration

The two following diagrams illustrate how DNS query resolutions for content delivery networks are processed by the 3-DNS Controller. In the example, the content provider for **www.download.siterequest.com** has two data centers, one in San Jose, California (see Figure 7.1), and one in Washington, DC (see Figure 7.2 on page 7-3). The 3-DNS Controllers (in the two data centers) use the Topology load balancing mode to direct the DNS queries to the geographically closest virtual servers.

In Figure 7.1, a local DNS server in Seattle, Washington, sends a query for the domain **www.download.siterequest.com** (1A). Based on the location information in the query packet header, the 3-DNS Controller in the content provider's North American data center resolves the query to the best virtual server in that data center, and sends an **A** record response to the Seattle LDNS (1B).

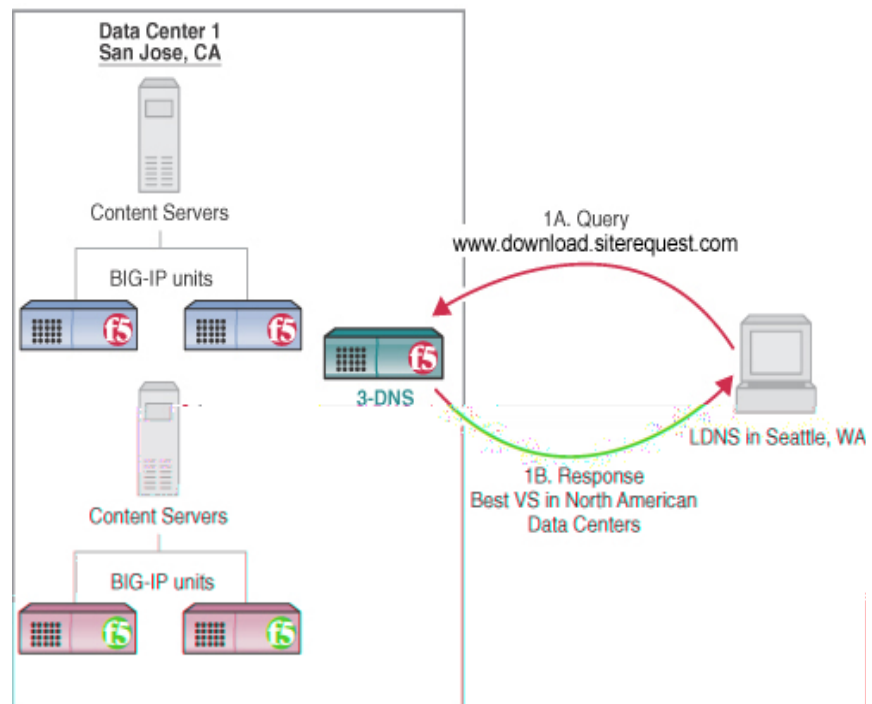

Figure 7.1 DNS query resolution based on Topology load balancing mode

In Figure 7.2, a local DNS server in London sends a query for the same domain, **www.download.siterequest.com** (2A). Based on the location information in the query packet header, the 3-DNS Controller in the content provider's North American data center responds to the London LDNS with delegation information (a **CNAME** record) about the DNS for the content delivery peer (2B). The London LDNS then sends the redirected query (based on the **CNAME** record) for **www.download.siterequest.com** to the

CDN provider (2C). The CDN provider's DNS server responds with the IP address of the best virtual server for resolution among those in the CDN (2D). The CDN provider's cache servers resolve to the origin site virtual servers for cache refreshes using a different domain name (**origin.download.siterequest.com**).

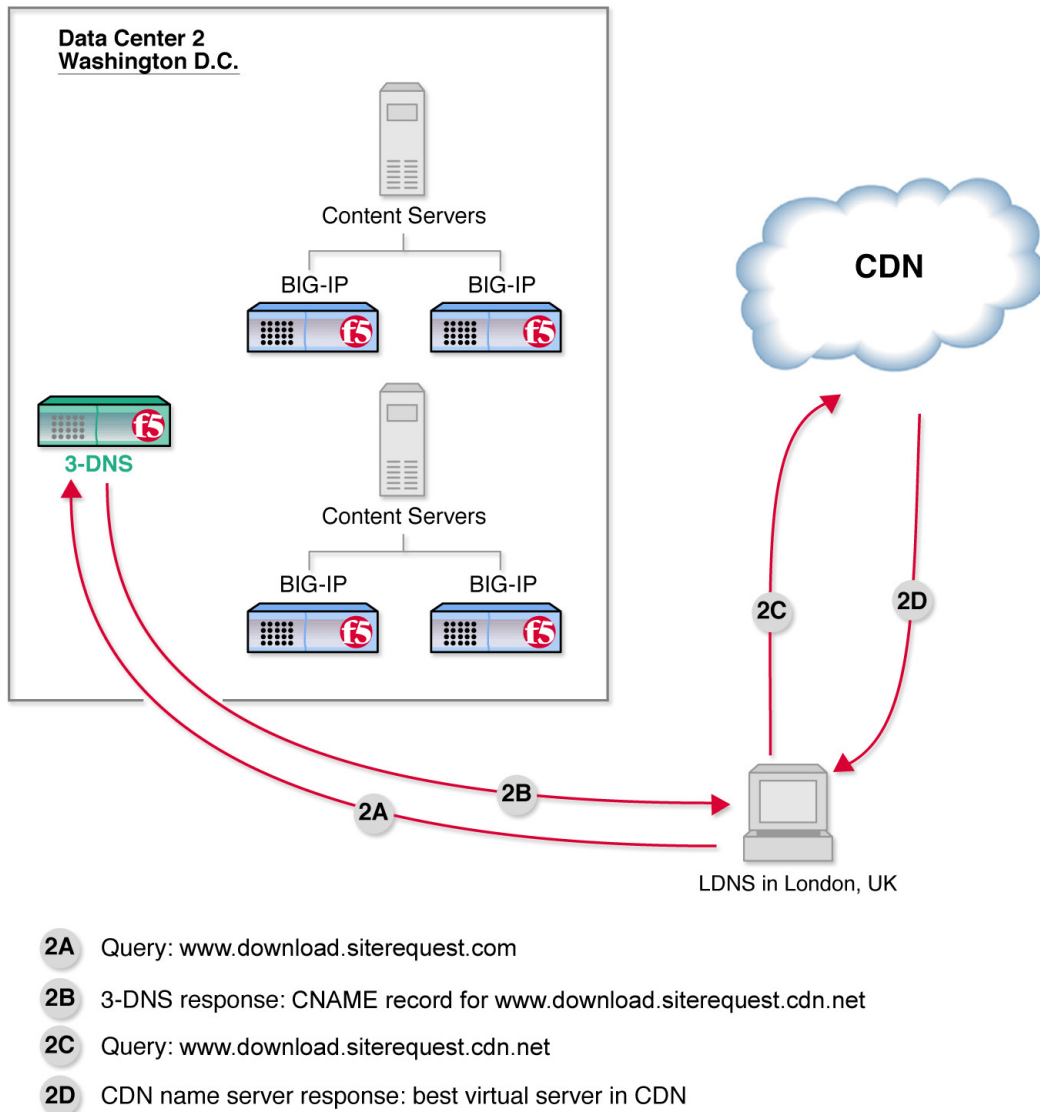

Figure 7.2 DNS query resolution to content delivery network provider

Deciding to use a CDN provider

The 3-DNS Controller is well-suited to serve as the wide-area traffic manager (WATM) for CDNs that have many of the following attributes:

- ◆ The CDN provider has a global presence around the edge of the Internet.
- ◆ The CDN provider outsources a content delivery infrastructure to content providers.
- ◆ The CDN provider is the authoritative DNS for the content provider's domain, and uses DNS to find a data center with CDN resources at the edge of the network nearest to the client.
- ◆ The CDN provider serves all of the content provider's traffic because the CDN is authoritative for the content provider's domain. Content providers manage this by creating logical groupings of their content under different domains. For example, an investment firm might have a CDN host their news content at **news.domain.cdn.net**, while they serve their stock quotes content with **quote.siterequest.com** from their corporate data center.
- ◆ The CDN provider sets its billing rates based on megabits per second. The CDN provider determines billing by collecting and processing edge cache and server logs.
- ◆ The CDN provider has an infrastructure in place to manage the multitude of geographically distributed devices.
- ◆ The CDN provider usually establishes some type of service level agreement (SLA) to ensure that content is being served faster from the CDN than from the content provider's origin servers.

Setting up a CDN provider configuration

The following sections describe the specific tasks you perform to set up a CDN provider configuration, as shown in the example configuration on page 7-2. The tasks are as follows:

- Adding data centers
- Adding 3-DNS Controllers
- Adding load balancing servers
- Adding wide IPs and pools
- Adding a topology statement

Adding data centers

The first task you perform is to add the data centers to the configuration on the 3-DNS Controller.

To add data centers using the Configuration utility

1. In the navigation pane, click **Data Centers**.
The Data Centers screen opens.
2. Click **Add Data Center** on the toolbar.
The Add Data Centers screen opens.
3. Add the data center information. For our example, we add the two data centers labeled **Data Center 1** and **Data Center 2**.
4. Repeat the previous steps to add all of your data centers to the configuration.

Adding 3-DNS Controllers

Once you have added all of your data centers to the 3-DNS configuration, you are ready to advise the 3-DNS Controller you are configuring about other 3-DNS Controllers in your network.

To add 3-DNS Controllers using the Configuration utility

1. In the navigation pane, expand the **Servers** item, then click **3-DNS**.
The 3-DNS List screen opens.
2. Click **Add 3-DNS** on the toolbar.
The Add New 3-DNS screen opens.
3. Add the 3-DNS Controller information.
4. Repeat the previous steps to add any additional 3-DNS Controllers to the configuration.

Configuration note

*Please note that when you are working with more than one 3-DNS Controller, you create your entire configuration on one system and then add the second system using the **3dns_add** script. The **3dns_add** script copies the entire configuration from the first system onto the second system, and synchronizes all of the settings. For details on configuring additional 3-DNS Controllers in existing networks, using the **3dns_add** script, see Chapter 10, **Adding a 3-DNS Controller to an Existing Network**.*

Adding load balancing servers

Now you are ready to let the 3-DNS Controller know about any BIG-IP systems, EDGE-FX systems, or hosts that you have in your data centers. The servers and virtual servers that you add to this configuration are the servers that load balance your origin site content. For specific information on configuring any of these server types, please review *Setting up servers*, on page 5-6.

Adding wide IPs and pools

Once you have added all the physical elements to the 3-DNS configuration, you can begin configuring wide IPs and pools for the CDN configuration. In addition to setting up the wide IPs and pools for your origin site, you also set up a pool for the CDN provider.

Before you start adding wide IPs, verify that you have configured all the virtual servers you need for load balancing for your origin site. The following instructions describe how to set up the CDN configuration shown in Figures 7.1 and 7.2.

To add a wide IP and pool using the Configuration utility

1. In the navigation pane, click **Wide IPs**.
The Wide IP List screen opens.
2. Click **Add Wide IP** on the toolbar.
The Add a New Wide IP screen opens.
3. Add the wide IP address, name, and port information. For our example, the wide IP name is **www.download.siterequest.com**.
4. For the **Pool LB Mode**, select **Topology** and click **Next**.
The Configure Load Balancing for New Pool screen opens.
5. In the Configure Load Balancing for New Pool screen, update these settings:
 - a) Add the pool name.
For our example, the first pool name is **origin**.
 - b) Check the **Use Dynamic Ratio** option.

- c) In the **Load Balancing Modes, Preferred** list, select **Round Trip Time**.
 - d) In the **Load Balancing Modes, Alternate** list, select **Packet Rate**.
 - e) In the **Load Balancing Modes, Fallback** list, select **Round Robin**.
 - f) Accept the defaults for the rest of the settings and click **Next**.
The Select Virtual Servers screen opens.
6. In the Select Virtual Servers screen, check the virtual servers among which you want the 3-DNS Controller to load balance DNS requests, and click **Finish**.
The 3-DNS Controller adds the wide IP and settings to the configuration. For our example, you would check the virtual servers that map to the download site content in the North American data center.

To add a CDN provider pool to the wide IP

1. In the navigation pane, click **Wide IPs**.
The Wide IP List screen opens.
2. In the Wide IP List screen, click **1 Pools** in the Pools column for the wide IP **www.download.siterequest.com**.
The Modify Wide IP Pools screen opens.
3. On the toolbar, click **Add Pool**.
The Configure Load Balancing for New Pool opens.
4. Update these settings:
 - a) Add the pool name.
For our example, the CDN provider pool name is **cdn_pool**.
 - b) In the Pool TTL box, type **60**. With a longer time-to-live, an LDNS has time to follow the **CNAME** record and redirect queries to the CDN.
 - c) In the **Dynamic Delegation, Type** list, select **CNAME**.
 - d) In the **Dynamic Delegation, Canonical Name** box, type the canonical name that you want the 3-DNS Controller to deliver in the **CNAME** record when it redirects traffic to the CDN provider. For our example, the canonical name is **www.download.siterequest.cdn.net**. Note that the canonical name for the CDN pool type automatically becomes an alias for the wide IP.
5. Click **Next**.
The Wide IP List screen opens.

You have now set up the load balancing and delegation pools for your domain. The last required configuration step is to create a topology statement.

Adding a topology statement

The topology statement contains the topology records that the 3-DNS Controller uses to load balance DNS queries from geographically dispersed local DNS servers. The following procedure describes how to set up a topology statement, with two topology records, for our example.

◆ Note

*For more detailed information on working with topology on the 3-DNS Controller, see Chapter 3, **Topology**, in the **3-DNS Reference Guide**. For information on setting up globally-distributed network with Topology load balancing, see Chapter 6, **Configuring a Globally-Distributed Network**, in this guide.*

To set up topology records using the Configuration utility

1. In the navigation pane, click **Topology**.
The Manage Topology Records screen opens.
2. For the first topology record, select **Continent** in the upper **LDNS** box.
3. In the lower **LDNS** box, select **North America**.
4. In the upper **Server** box, select **Wide IP Pool**.
5. In the lower **Server** box, select **origin**.
6. In the **Weight** box, type a value. For our example, we type **100**.
7. Click **Add**.
The first topology record is added to the configuration.
8. For the second topology record, in the upper **LDNS** box select **Continent**.
9. In the lower **LDNS** box, select **North America**.
10. Check the **LDNS Not Equal** box.
11. In the upper **Server** box, select **Wide IP Pool**.
12. In the lower **Server** box, select **cdn_pool**.
13. In the **Weight** box, type a value. For our example, we type **100**.
14. Click **Add**.
The second topology record is added to the configuration.

Now you have created a topology statement for your CDN, and the 3-DNS Controller can successfully load balance DNS queries based on the location information derived from the DNS query message. For our example, using the topology statement you just created, the 3-DNS Controller would direct queries for **www.download.siterequest.com** that originated in North America to the **origin** pool for resolution. Requests that did not originate in North America would be directed to the CDN provider using the **cdn_pool**.

Ensuring resource availability

The following resource availability settings are designed to ensure that your content is always available and that your system resources are not overtaxed to the point of failure. The resource availability settings you may want to use with your CDN configuration are:

- ◆ **Last resort pool**

You can designate a pool as the last resort pool so in the event that all other pools become unavailable for load balancing, the 3-DNS Controller can direct DNS queries to the virtual servers in this pool. For information on configuring a last resort pool, see *Using the last resort pool designation* in Chapter 2, *Load Balancing*, in the **3-DNS Reference Guide**.

- ◆ **Limit settings**

You can set limits on system resources and throughput to enhance availability. You can set limits for any server type, virtual servers, and pools. For more information on setting limits, view the online help for the Modify Limit Settings screens in the Configuration utility.

- ◆ **ECV monitor**

With an extended content verification (ECV) monitor, you can verify that a specific file is available on the content servers for a wide IP. For more information on ECV monitors, refer to *Working with the ECV service monitor*, in the **3-DNS Reference Guide**, Chapter 2, *Load Balancing*.

Monitoring the configuration

The following resources can help you monitor your configuration and troubleshoot problems.

- ◆ You can view performance metrics, limit settings, and other details about your data centers, servers, virtual servers, wide IPs, and pools in the Statistics screens in the Configuration utility. For more information on specific Statistics screens, click **Help** on the toolbar.
- ◆ You can view your configuration using the Network Map in the Configuration utility. You can also make modifications to the configuration from the Network Map. Click **Help** on the toolbar if you have questions on how to use the Network Map.
- ◆ You can review detailed information on the specific features of the 3-DNS Controller in the *3-DNS Reference Guide*.



8

Working with Quality of Service

- Overview of Quality of Service
- Understanding QOS coefficients
- Customizing the QOS equation
- Using the Dynamic Ratio option

Overview of Quality of Service

The Quality of Service mode is a dynamic load balancing mode that includes a configurable combination of the Round Trip Time (RTT), Completion Rate, Packet Rate, Topology, Hops, Link Capacity, VS Capacity, and Kilobytes/Second (KBPS) modes. The Quality of Service mode is based on an equation that takes each of these performance factors into account. When the 3-DNS Controller selects a virtual server, it chooses the server with the best overall score.

The Quality of Service mode has default settings that make it easy to use: simply specify Quality of Service as your preferred load balancing mode. There is no need to configure Quality of Service, but if you want to change the settings, you can customize the equation to put more or less weight on each individual factor. The following topics explain how to use and adjust the various settings.

Understanding QOS coefficients

Table 8.1 lists each Quality of Service (QOS) coefficient, its scale, a likely upper limit for each, and whether a higher or lower value is more efficient.

Coefficient	How measured	Default value	Example upper limit	Higher or lower?
Packet rate	Packets per second	1	700	Lower
Round trip time	Microseconds	50	2,000,000	Lower
Completion rate	Percentage of successfully transferred packets (0-100%)	5	100%	Higher
Topology	Score that defines network proximity by comparing server and LDNS IP addresses (0-2 ³²)	0	100	Higher
Hops	Number of intermediate systems transitions (hops)	0	64	Lower
Link Capacity	Bandwidth usage	30	2,000,000	Higher
VS capacity	Number of nodes <i>up</i>	0	20	Higher
Kilobytes/second	Kilobytes per second throughput	3	15000	Lower

Table 8.1 QOS coefficients: Default values, ranges, and limits

If you change the default QOS coefficients, keep the following issues in mind.

◆ **Scale**

The raw metrics for each coefficient are not on the same scale. For example, completion rate is measured in percentages, while the packet rate is measured in packets per second.

◆ **Normalization**

The 3-DNS Controller normalizes the raw metrics to values in the range of 0 to 10. As the QOS value is calculated, a high measurement for completion rate is good, because a high percentage of completed connections are being made, but a high value for packet rate is not desirable because the packet rate load balancing mode attempts to find a virtual server that is not overly taxed at the moment.

- **Emphasis**

You can adjust coefficients to emphasize one normalized metric over another. For example, by changing the coefficients to the values shown in Figure 8.1, you are putting the most emphasis on completion rate.

```
globals {
    qos_coeff_rtt 50
    qos_coeff_completion_rate 100
    qos_coeff_packet_rate 1
    qos_coeff_topology 0
    qos_coeff_hops 0
    qos_coeff_lcs
    qos_coeff_vs_capacity 0
    qos_coeff_kbps 0
}
```

Figure 8.1 QOS coefficients emphasizing completion rate

In the preceding example, if the completion rates for two virtual servers are close, the virtual server with the best packet rate is chosen. If both the completion rates and the packet rates are close, the round trip time (RTT) breaks the tie. In this example, the metrics for Topology, Hops, Link Capacity, VS Capacity, and Kilobytes/Second modes are not used in determining how to distribute connections.

Customizing the QOS equation

You can customize the QOS equation globally, meaning that the equation applies to all wide IPs that use the Quality of Service mode. You can also customize individual wide IPs, in which case the global QOS equation settings are overwritten.

To modify global QOS coefficients using the Configuration utility

1. In the navigation pane, click **System**.
The System - General screen opens.
2. On the toolbar, click **Load Balancing**.
The System - Load Balancing screen opens.
3. Define the global QOS coefficients in the **Round Trip Time**, **Completion Rate**, **Hops**, **BIG-IP Packet Rate**, **Topology**, **Link Capacity**, **VS Capacity**, and **Kilobytes/Second** boxes.
4. Click **Update**.

To modify QOS coefficients for a specific wide IP using the Configuration utility

1. In the navigation pane, click **Wide IPs**.
2. In the Wide IP column, click a wide IP name.
The Modify Wide IP screen opens.
3. On the toolbar, click **Modify Pool**.
The Modify Wide IP Pools screen opens.
4. In the Pool Name column, click the name of a pool.
The Modify Load Balancing screen opens.
5. Define the wide IP's QOS coefficients in the **Round Trip Time**, **Completion Rate**, **Hops**, **BIG-IP Packet Rate**, **Topology**, **Link Capacity**, **VS Capacity**, and **Kilobytes/Second** boxes.
6. Click **Update**.

To assign global QOS coefficients from the command line

1. Type the following command to ensure that the configuration files contain the same information as the memory cache.
3ndc dumpdb
2. Open the **wideip.conf** file in a text editor (either **vi** or **pico**).
3. Locate or add the **globals** statement. The **globals** statement should be at the top of the file.
4. Refer to the example syntax shown in Figure 8.2 to define a global QOS equation. Note that Figure 8.2 shows the default values for the QOS coefficients.
5. Save and close the file.
6. Commit the changes to the configuration by typing:
3ndc reload

```
globals {
    qos_coeff_rtt 50
    qos_coeff_completion_rate 5
    qos_coeff_packet_rate 1
    qos_coeff_topology 0
    qos_coeff_hops 0
    qos_coeff_lcs 30
    qos_coeff_vs_capacity 0
    qos_coeff_kbps 0
}
```

Figure 8.2 Sample global QOS equation

To assign QOS coefficients for a specific wide IP from the command line

1. Type the following command to ensure that the configuration files contain the same information as the memory cache.

```
3ndc dumpdb
```

2. Open the **wideip.conf** file in a text editor (either **vi** or **pico**).
3. Locate or add the **globals** statement. The **globals** statement should be at the top of the file.
4. Refer to the example syntax shown in Figure 8.3 to define a wide IP's QOS equation. Figure 8.3 displays a wide IP definition that overrides the global QOS equation settings shown in Figure 8.2.
5. Save and close the file.
6. Commit the changes to the configuration by typing:

```
3ndc reload
```

```
wideip {
  address      192.168.101.50
  service      "http"
  name         "www.wip.siterequest.com"
  ttl          60 // increase the domain default ttl
  qos_coeff {
    rtt         21
    hops        0
    completion_rate 7
    packet_rate 5
    topology    1
    vs_capacity 0
    kbps        0
  }
  pool {
    name        "Pool_1"
    ratio       2 // applies to pool_lbmode == ratio
    preferred   qos
    alternate   ratio
    address     192.168.101.50 ratio 2
    address     192.168.102.50 ratio 1
    address     192.168.103.50 ratio 1
  }
  pool {
    name        "Pool_2"
    ratio       1
    preferred   rr
    address     192.168.102.60 ratio 2
    address     192.168.103.60 ratio 1
  }
}
```

Figure 8.3 QOS coefficient settings that override the global QOS settings

Using the Dynamic Ratio option

When the Dynamic Ratio option is turned on, the 3-DNS Controller treats QOS scores as ratios, and it uses each server in proportion to the ratio determined by the QOS calculation. When the Dynamic Ratio option is turned off (the default), the 3-DNS Controller uses only the server with the highest QOS score for load balancing, (in which case it is a winner-takes-all situation) until the metrics information is refreshed.

To turn on the Dynamic Ratio option using the Configuration utility

1. In the navigation pane, click **Wide IPs**.
2. In the Wide IP column, click a wide IP name.
The Modify Wide IP screen opens.
3. On the toolbar, click **Modify Pool**.
The Modify Wide IP Pools screen opens.
4. In the Pool Name column, click the name of a pool.
The Modify Load Balancing screen opens.
5. Check **Use Dynamic Ratio**.
6. Click **Update**.

To turn on the Dynamic Ratio option from the command line

1. To ensure that the configuration files contain the same information as the memory cache, type the following command:

```
3ndc dumpdb
```
2. Open the **wideip.conf** file in a text editor (either **vi** or **pico**).
3. Locate the **wideip** statement and the pool definition you want to edit.
4. Add the syntax (shown in bold in Figure 8.4) to the pool definition.
5. Save and close the file.

6. Commit the changes to the configuration by typing:

3ndc reload

```
pool {
  name <"pool_name">
  [ ratio <pool_ratio> ]
  dynamic_ratio yes
  [ rr_ldns < yes | no > ]
  [ rr_ldns_limit <number> ]
  [ preferred < completion_rate | ga | hops | kbps | leastconn | packet_rate | qos |
random | ratio | return_to_dns | rr |
  rtt | static_persist | topology | vs_capacity | null > ]
  [ alternate < ga | kbps | null | random | ratio | return_to_dns | rr |
static_persist | topology | vs_capacity > ]
  [ fallback < completion_rate | ga | hops | kbps | leastconn |
  packet_rate | qos | random | ratio | return_to_dns | rr | rtt | static_persist |
topology | vs_capacity | null > ]
  address <vs_addr>[:<port>] [ratio <weight>]
}
}
```

Figure 8.4 Enabling dynamic ratio in a pool configuration



9

Working with Global Availability Load Balancing

- Overview of the Global Availability load balancing mode
- Configuring the Global Availability mode

Overview of the Global Availability load balancing mode

You can use the Global Availability mode in one of two ways: either to load balance among wide IP pools, or to load balance within a wide IP pool.

When you use the Global Availability mode to load balance among pools, the 3-DNS Controller continually sends requests to the first pool in the wide IP. When all the virtual servers in the pool become unavailable, the pool is marked unavailable and the 3-DNS Controller starts sending requests to the next pool listed in the wide IP. When the first pool is available again, the 3-DNS Controller stops sending requests to the second pool, and starts sending them to the first pool again. If you have an origin site and an overflow network, such as a CDN, you can use Global Availability to load balance between the two networks.

When you use the Global Availability mode to load balance virtual servers within a pool, the load balancing works in much the same way. The 3-DNS Controller repeatedly selects the first available virtual server in the wide IP pool to respond to requests. If that virtual server becomes unavailable, subsequent connections go to the next available virtual server listed in the pool. When the first listed virtual server becomes available again, the 3-DNS Controller distributes requests to it again.

Figure 9.1 shows the 3-DNS Controller using the Global Availability load balancing mode.

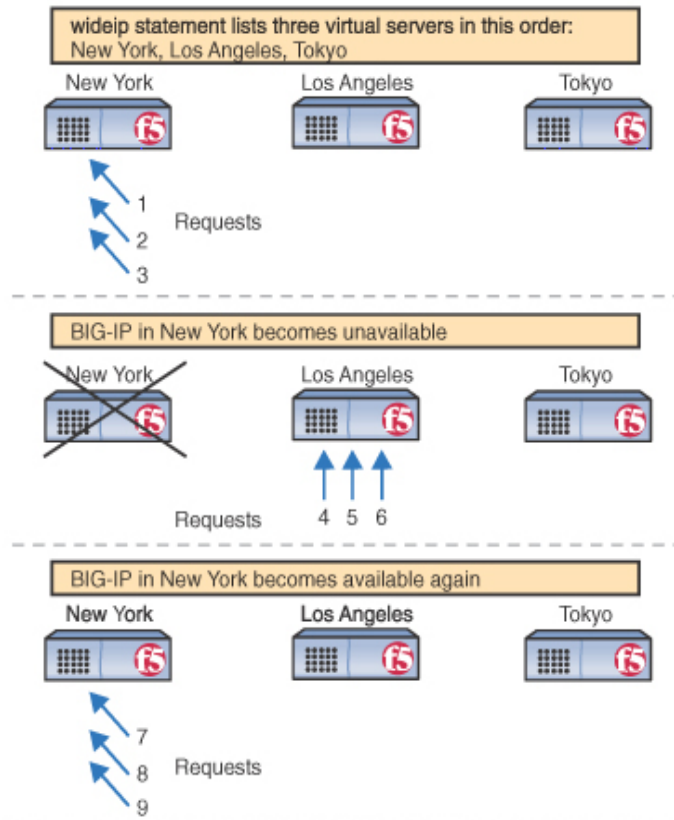

Figure 9.1 Global Availability mode

Configuring the Global Availability mode

The following sections describe how to configure the Global Availability load balancing mode to load balance among pools and to load balance within a pool.

To configure the Global Availability load balancing mode among pools using the Configuration utility

1. In the navigation pane, click **Wide IPs**.
2. In the Wide IP column, click a wide IP name.
The Modify Wide IP screen opens.
3. In the **Pool LB Mode** box, select **Global Availability**.
4. Click **Update**.
5. A popup screen appears, indicating that with the Global Availability load balancing mode you must order the pools. Click **OK**.
The Modify Virtual Servers screen opens.
6. In the Order column, specify the order in which you want to list the pools for Global Availability.
7. Click **Update**.

To configure the Global Availability load balancing mode among pools from the command line

1. To ensure that the configuration files contain the same information as the memory cache, type the following command:

```
3ndc dumpdb
```
2. Open the **wideip.conf** file in a text editor (either **vi** or **pico**).
3. Locate the **wideip** statement you want to edit.
4. Define the pool load balancing mode as Global Availability:

```
pool_lbmode ga
```
5. List the pools in the wide IP in descending order of preference.
6. Save and close the file.
7. Commit the changes to the configuration by typing:

```
3ndc reload
```

To configure the Global Availability load balancing mode within a pool using the Configuration utility

1. In the navigation pane, click **Wide IPs**.
2. In the Wide IP column, click a wide IP name.
The Modify Wide IP screen opens.

3. On the toolbar, click **Modify Pool**.
The Modify Wide IP Pools screen opens.
4. In the Pool Name column, click the name of a pool.
The Modify Load Balancing screen opens.
5. Select **Global Availability** as the **Preferred**, **Alternate**, or **Fallback** load balancing mode.
6. Click **Update**.
7. A popup screen appears, indicating that with the Global Availability load balancing mode you must order the virtual servers. Click **OK**.
The Modify Virtual Servers screen opens.
8. In the Order column, specify the order in which you want to list the virtual servers for Global Availability.
9. Click **Update**.

To configure the Global Availability load balancing mode within a pool from the command line

1. To ensure that the configuration files contain the same information as the memory cache, type the following command:

```
3ndc dumpdb
```
2. Open the **wideip.conf** file in a text editor (either **vi** or **pico**).
3. Locate the **wideip** statement you want to edit.
4. Define Global Availability as the preferred, alternate, or fallback load balancing mode within the pool that you want to modify.
5. List the virtual servers in the wide IP in descending order of preference.
6. Save and close the file.
7. Commit the changes to the configuration by typing:

```
3ndc reload
```

See Figure 9.2, on page 9-5, for an example of the syntax.

A Global Availability configuration example

With the Global Availability load balancing mode, you can configure one data center as your primary service provider and have several alternate service providers on standby. In the **wideip** statement, list the virtual servers in descending order of preference. The first available virtual server is chosen for each resolution request.

Figure 9.2 shows a sample **wideip** definition, in the **wideip.conf** file, where Global Availability is the preferred load balancing mode within a pool.

```
// Global availability
wideip {
  address      192.168.101.50
  port         80 // http
  name         "cgi.wip.siterequest.com"
  pool {
    name       "mypool"
    preferred  ga
    address    192.168.101.60 //New York data center
    address    192.168.102.60 //Los Angeles data center
    address    192.168.103.60 //Tokyo data center
  }
}
```

Figure 9.2 Configuring a standby data center using Global Availability

The first listed virtual server (**192.168.101.60** in this example) receives all resolution requests unless it becomes unavailable. If the first listed virtual server does become unavailable, then the 3-DNS Controller sends resolution requests to the second listed virtual server until the first listed virtual server becomes available again.



10

Adding a 3-DNS Controller to an Existing Network

- Working with multiple 3-DNS Controllers
- Preparing to add a second 3-DNS Controller to your network
- Running the 3dns_add script
- Verifying the configuration

Working with multiple 3-DNS Controllers

When you are working with more than one 3-DNS Controller in your network, and you want the systems to load balance to the same virtual servers, you can create your entire configuration on one system and then add the second system using the **3dns_add** script. The **3dns_add** script copies the entire configuration from the first system onto the second system, and synchronizes all of the settings between the systems. (For more information about sync groups, see *Working with sync groups*, on page 5-14.)

The following sections of this chapter describe the procedures you follow to add a 3-DNS Controller into a network that already has at least one 3-DNS Controller configured and working properly. If you are adding the first 3-DNS Controller to your network, refer to Chapter 5, *Essential Configuration Tasks*.

◆ Important

*If you are adding a second 3-DNS Controller to your network but do not want it to be in the same sync group as your first system, or you want the second 3-DNS Controller to load balance to a different set of virtual servers, then do not use the **3dns_add** script.*

Preparing to add a second 3-DNS Controller to your network

Before you run the **3dns_add** script on any additional 3-DNS Controllers you are adding to your network, you should complete the following tasks:

- ◆ Physically install the second 3-DNS Controller in its data center. (For more information on hardware installation, refer to the *Platform Guide* that shipped with the unit.)
- ◆ Run the Setup utility on the second system. (For more information on the Setup utility, see Chapter 3, *Using the Setup Utility*, or if you are running the 3-DNS Controller module on a BIG-IP system, refer to the *BIG-IP Reference Guide*.)
- ◆ Make the existing 3-DNS Controller aware of the IP address, fully-qualified domain name, and data center location of the second 3-DNS Controller. (See *Making the existing 3-DNS Controller aware of the additional controller*, on page 10-3.)
- ◆ Add the new 3-DNS Controller to the sync group of the existing 3-DNS Controller.

Completing these tasks ensures that when you run the **3dns_add** script, the second 3-DNS Controller successfully copies the configuration information from the first 3-DNS Controller.

*If you are using a sync group, we strongly recommend that you run the **3dns_add** script to add additional 3-DNS Controllers to your network. If you do not use the script, you risk overwriting your current configuration.*

Installing the hardware and running the Setup utility

You can find detailed instructions on installing the 3-DNS hardware in the *Platform Guide 520/540*. You can find detailed instructions on running the Setup utility in Chapter 3, *Using the Setup Utility*, in this guide. When you have finished this part of the setup for the second system, do not make any other changes to the configuration.

◆ Note

*If you are working with the 3-DNS Controller module on a BIG-IP system, please refer to the *BIG-IP Administrator Kit* for information on installing the hardware and running the Setup utility.*

Making the existing 3-DNS Controller aware of the additional controller

Once you have installed the hardware and run the Setup utility on the new system, you add its configuration information to the existing 3-DNS Controller (the 3-DNS Controller that is already installed in your network).

To add the new controller to the existing controller's configuration using the Configuration utility

1. Add the second data center to the configuration.
 - a) In the navigation pane, click **Data Centers**.
The Data Centers screen opens.
 - b) Click **Add Data Center** on the toolbar.
The Add Data Centers screen opens.
 - c) Add the information for the data center where you installed the new system, and click **Update**.
2. Add the second 3-DNS Controller to the configuration.
 - a) In the navigation pane, expand the **Servers** item, and click **3-DNS**.
The 3-DNS List screen opens.
 - b) Click **Add 3-DNS** on the toolbar.
The Add New 3-DNS screen opens.
 - c) Add the information for the new system, and click **Update**.
3. Add the new controller to the existing controller's sync group.
 - a) In the navigation pane, click **3-DNS Sync**.
The System-Synchronization screen opens.
 - b) Click **Add to Group** on the toolbar.
The Add a 3-DNS to a Sync Group screen opens.
 - c) Check the 3-DNS Controller you just defined, and click **Add**.
The new controller becomes a member of the sync group of the existing controller.

You have now successfully added the new 3-DNS Controller to the existing system's configuration and sync group. The following sections describe how to run the **3dns_add** script and verify the configuration.

Running the 3dns_add script

You can run the **3dns_add** script on the new 3-DNS Controller either by using a remote secure shell session, or by using a monitor and keyboard connected directly to the controller.

To run the 3dns_add script

1. At the **login** prompt on the new controller, type **root**.
2. At the **password** prompt, type the password you configured when you ran the Setup utility.
3. To run the script, type **3dns_add** at the command line.
The script performs the following tasks:
 - Copies the existing controller's configuration to the new controller
 - Sets up SSH communications between the new controller and existing F5 devices in the network
 - Copies the existing controller's iQuery key to the new controller so communications between the controller and the **big3d** agents are secure
 - Gives you the option of synchronizing the **named.conf** file and any existing zone files

Verifying the configuration

Once the script finishes, we recommend that you verify the following aspects of your configuration:

- Verify that each 3-DNS Controller has the necessary agents and daemons running.
- Verify that any servers you configured are **up** and available to receive load balancing requests.
- Verify that any virtual servers you configured are **up** and available to respond to requests.
- Verify that any wide IPs you configured are load balancing requests as you configured them.

You can perform these verification tasks on any of the systems in the sync group. The following procedures describe the verification process in detail.

To verify that each 3-DNS Controller has the necessary agents and daemons running

1. In the navigation pane, expand the **Statistics** item, and click **3-DNS**. The 3-DNS Statistics screen opens.

2. In the Server and Big3d columns, make sure the status is **up**, which is indicated by a green ball.
3. In the E/D column, make sure the systems are **enabled**.
4. If the status of any of your systems is **down**, **unknown**, or **unavailable**, wait a few minutes and click **Refresh**. If status of the systems remains **down**, **unknown**, or **unavailable**, contact Technical Support for assistance.

To verify that the servers you configured are up

1. In the navigation pane, expand the **Statistics** item, and click **Data Centers**.
The Data Centers Statistics screen opens.
2. In the Server column, make sure that the status of each server is **up**, which is indicated by a green ball.
3. If the status of any of your servers is **down**, **unknown**, or **unavailable**, wait a few minutes and click **Refresh**. If status of the servers remains **down**, **unknown**, or **unavailable**, contact Technical Support for assistance.

To verify that the virtual servers you configured are up

1. In the navigation pane, expand the **Statistics** item and click **Virtual Servers**.
The Virtual Servers Statistics screen opens.
2. In the OK column, make sure that the status of each virtual server you configured is **up**, which is indicated by a green ball.
3. If the status of any of your virtual servers is **down**, **unknown**, or **unavailable**, wait a few minutes and click **Refresh**. If status of the virtual servers remains **down**, **unknown**, or **unavailable**, contact Technical Support for assistance.

To verify that the wide IPs are load balancing properly

At the command prompt, type the following command, where **<IP_address>** is the IP address of one of your 3-DNS Controllers, and **<wideip>** is the name of a wide IP in the configuration, and press Enter.

```
dig @<IP_address> <wideip>
```

If the virtual servers belonging to the wide IP appear in a pattern that reflects the load balancing mode you selected, you have successfully configured your 3-DNS Controllers. Note that you can repeat the previous procedure for each wide IP you configured, and each controller in the sync group.

◆ **Note**

*This is the only verification task that you perform from the command line. The **dig** utility is part of DNS distributions. For more information on the **dig** utility, type **man dig** at the command line to view the man page.*



Glossary

3-DNS Distributed Traffic Controller

The 3-DNS Distributed Traffic Controller is a wide area load distribution solution that intelligently allocates Internet and intranet service requests across geographically distributed network servers. The 3-DNS Distributed Traffic Controller is also most often referred to as the 3-DNS Controller.

3-DNS Maintenance menu

The 3-DNS Maintenance menu is a command line utility that you use to configure the 3-DNS Controller.

3-DNS web server

The 3-DNS web server is a standard web server that hosts the Configuration utility on the 3-DNS Controller.

A record

The **A** record is the ADDRESS resource record that a 3-DNS Controller returns to a local DNS server in response to a name resolution request. The **A** record contains a variety of information, including one or more IP addresses that resolve to the requested domain name.

access control list (ACL)

An access control list is a list of local DNS server IP addresses that are excluded from path probing or hops queries.

active unit

In a redundant system, an active unit is a 3-DNS Controller that currently load balances name resolution requests. If the active unit in the redundant system fails, the standby unit assumes control and begins to load balance requests.

alternate method

The alternate method specifies the load balancing mode that the 3-DNS Controller uses to pick a virtual server if the preferred method fails. See also *fallback method*, *preferred method*.

big3d agent

The **big3d** agent is a monitoring agent that collects metrics information about server performance and network paths between a data center and a specific local DNS server. The 3-DNS Controller uses the information collected by the **big3d** agent for dynamic load balancing.

BIND (Berkeley Internet Name Domain)

BIND is the most common implementation of the Domain Name System (DNS). BIND provides a system for matching domain names to IP addresses. For more information, refer to <http://www.isc.org/products/BIND>.

CDN switching

CDN switching is the functionality of the 3-DNS Controller that allows a user to redirect traffic to a third-party network, or transparently switch traffic to a CDN. The two features of the 3-DNS Controller that make CDN switching possible are geographic redirection and the pool type CDN.

CNAME record

A canonical name (CNAME) record acts as an alias to another domain name. A canonical name and its alias can belong to different zones so the **CNAME** record must always be entered as a fully qualified domain name. **CNAME** records are useful for setting up logical names for network services so that they can be easily relocated to different physical hosts.

completion rate

The completion rate is the percentage of packets that a server successfully returns during a given session.

Completion Rate mode

The Completion Rate mode is a dynamic load balancing mode that distributes connections based on which network path drops the fewest packets, or allows the fewest number of packets to time out.

Configuration utility

The Configuration utility is the browser-based application that you use to configure the 3-DNS Controller.

content delivery network (CDN)

A content delivery network (CDN) is an architecture of Web-based network components that helps dramatically reduce the wide-area network latency between a client and the content they wish to access. A CDN includes some or all of the following network components: wide-area traffic managers, Internet service providers, content server clusters, caches, and origin content providers.

data center

A data center is a physical location that houses one or more 3-DNS Controllers, BIG-IP systems, EDGE-FX Caches, GLOBAL-SITE Controllers, or host machines.

data center server

A data center server is any server recognized in the 3-DNS Controller configuration. A data center server can be any of the following: a 3-DNS Controller, a BIG-IP system, an EDGE-FX Cache, a GLOBAL-SITE Controller, or a host.

domain name

A domain name is a unique name that is associated with one or more IP addresses. Domain names are used in URLs to identify particular Web pages. For example, in the URL <http://www.siterequest.com/index.html>, the domain name is **siterequest.com**.

dynamic load balancing modes

Dynamic load balancing modes base the distribution of name resolution requests to virtual servers on live data, such as current server performance and current connection load.

dynamic site content

Dynamic site content is a type of site content that is automatically generated each time a user accesses the site. Examples are current stock quotes or weather satellite images.

ECV (Extended Content Verification)

On the 3-DNS Controller, ECV is a service monitor that checks the availability of actual content, (such as a file or an image) on a server, rather than just checking the availability of a port or service, such as HTTP on port 80.

external interface

An external interface is the network interface that can be accessed across a wide-area network (WAN). See also *internal interface*.

fail-over

Fail-over is the process whereby a standby unit in a redundant system takes over when a software failure or hardware failure is detected on the active unit.

fail-over cable

The fail-over cable is the cable that directly connects the two units in a hardware-based redundant system.

fallback method

The fallback method is the third method in a load balancing hierarchy that the 3-DNS Controller uses to load balance a resolution request. The 3-DNS Controller uses the fallback method only when the load balancing modes specified for the preferred and alternate methods fail. Unlike the preferred method and the alternate method, the fallback method uses neither server nor virtual server availability for load balancing calculations. See also *preferred method*, *alternate method*.

FDDI (Fiber Distributed Data Interface)

FDDI is a multi-mode protocol for transmitting data on optical-fiber cables at speeds up to 100 Mbps.

Global Availability mode

Global Availability is a static load balancing mode that bases connection distribution on a particular server order, always sending a connection to the first available server in the list. This mode differs from Round Robin mode in that it searches for an available server always starting with the first server in the list, while Round Robin mode searches for an available server starting with the next server in the list (with respect to the server selected for the previous connection request).

hops factory

A hops factory is a type of factory run by the **big3d** agent that collects hops data about network paths.

host

A host is a network server that manages one or more virtual servers that the 3-DNS Controller uses for load balancing.

ICMP (Internet Control Message Protocol)

ICMP is an Internet communications protocol used to determine information about routes to destination addresses, such as virtual servers managed by 3-DNS Controllers and BIG-IP systems.

internal interface

An internal interface is a network interface that can be accessed from a local-area network (LAN). See also *external interface*.

iQuery

The iQuery protocol is used to exchange information between 3-DNS Controllers, BIG-IP systems, EDGE-FX Caches, and GLOBAL-SITE Controllers. The iQuery protocol is officially registered with IANA for port 4353, and works on UDP and TCP connections.

Kilobytes/Second mode

The Kilobytes/Second mode is a dynamic load balancing mode that distributes connections based on which available server currently processes the fewest kilobytes per second.

Least Connections mode

The Least Connections mode is a dynamic load balancing mode that bases connection distribution on which server currently manages the fewest open connections.

load balancing methods

Load balancing methods are the settings that specify the hierarchical order in which the 3-DNS Controller uses three load balancing modes. The preferred method specifies the first load balancing mode that the 3-DNS Controller tries, the alternate method specifies the next load balancing mode

to try if the preferred method fails, and the fallback method specifies the last load balancing mode to use if both the preferred and the alternate methods fail.

load balancing mode

A load balancing mode is the way in which the 3-DNS Controller determines how to distribute connections across an array.

local DNS

A local DNS is a server that makes name resolution requests on behalf of a client. With respect to the 3-DNS Controller, local DNS servers are the source of name resolution requests. Also referred to as LDNS.

metrics information

Metrics information is the data that is typically collected about the paths between BIG-IP systems, EDGE-FX Caches or GLOBAL-SITE Controllers, and local DNS servers. Metrics information is also collected about the performance and availability of virtual servers. Metrics information is used for load balancing, and it can include statistics such as round trip time, packet rate, and packet loss.

MindTerm SSH

MindTerm SSH is the third-party application on 3-DNS Controllers that uses SSH for secure remote communications. SSH encrypts all network traffic (including passwords) to effectively eliminate eavesdropping, connection hijacking, and other network-level attacks. SSH also provides secure tunneling capabilities and a variety of authentication methods.

name resolution

Name resolution is the process by which a name server matches a domain name request to an IP address, and sends the information to the client requesting the resolution.

name server

A name server is a server that maintains a DNS database, and resolves domain name requests to IP addresses using that database.

named

The **named** daemon manages domain name server software.

NameSurfer

NameSurfer is the third-party application on 3-DNS Controllers that automatically manages DNS zone files, synchronizing them with the configuration on the 3-DNS Controller. NameSurfer automatically updates any configuration changes that you make using the Configuration utility. NameSurfer also provides a graphical user interface for DNS zone file management.

NS record

A name server (NS) record is used to define a set of authoritative name servers for a DNS zone. A name server is considered authoritative for some given zone when it has a complete set of data for the zone, allowing it to answer queries about the zone on its own, without needing to consult another name server.

NTP (Network Time Protocol)

NTP functions over the Internet to synchronize system clocks to Universal Coordinated Time. NTP provides a mechanism to set and maintain clock synchronization within milliseconds.

packet rate

The packet rate is the number of data packets per second processed by a server.

Packet Rate mode

The Packet Rate mode is a dynamic load balancing mode that distributes connections based on which available server currently processes the fewest packets per second.

path

A path is a logical network route between a data center server and a local DNS server.

path probing

Path probing is the collection of metrics data, such as round trip time and packet rate, for a given path between a requesting LDNS server and a data center server.

persistence

On a 3-DNS Controller, persistence is a series of related requests received from the same local DNS server for the same wide IP name. When persistence is turned on, a 3-DNS Controller sends all requests from a particular local DNS server for a specific wide IP to the same virtual server, instead of load balancing the requests.

picks

Picks represent the number of times a particular virtual server is selected to receive a load balanced connection.

pool

A pool is a group of virtual servers managed by a BIG-IP, an EDGE-FX Cache, or a host. The 3-DNS Controller load balances among pools (using the Pool LB Mode), as well as among individual virtual servers.

pool ratio

A pool ratio is a ratio weight applied to pools in a wide IP. If the Pool LB mode is set to Ratio, the 3-DNS Controller uses each pool for load balancing in proportion to the weight defined for the pool.

preferred method

The preferred method specifies the first load balancing mode that the 3-DNS Controller uses to load balance a resolution request. See also *alternate method*, *fallback method*.

principal 3-DNS

A 3-DNS that initiates metrics collection by the **big3d** agents and distributes the metrics to other members of a sync group. See also *receiver 3-DNS*.

probe protocol

The probe protocol is the specific protocol used to probe a given path and collect metrics information for the path. The probe protocols available on the 3-DNS Controller are: ICMP, DNS_REV, DNS_DOT, UDP, and TCP. The probe protocols that are available change based on the data center server type.

prober

A prober is a specific thread of the **big3d** agent that is used for path probing of a given set of paths.

prober factory

A prober factory is a utility that collects metrics data, such as round trip time and packet rate, for a given path between a requesting LDNS and a data center server. Prober factories are managed by the **big3d** agent, which reports the path probing metrics to the 3-DNS Controller. Prober factories can run on BIG-IP systems, EDGE-FX Caches, and GLOBAL-SITE Controllers.

production rule

A production rule, on the 3-DNS Controller, can change system behavior under specific operating conditions. For example, a production rule can switch load balancing modes or can reroute network traffic to a specific set of servers. Production rules are based on triggers such as time of day or current network traffic load.

QOS equation

The QOS equation is the equation on which the Quality of Service load balancing mode is based. The equation calculates a score for a given path between a data center server and a local DNS server. The Quality of Service mode distributes connections based on the best path score for an available data center server. You can apply weights to the factors in the equation, such as round trip time and completion rate.

Quality of Service load balancing mode

The Quality of Service load balancing mode is a dynamic load balancing mode that bases connection distribution on a configurable combination of the packet rate, completion rate, round trip time, hops, virtual server capacity, kilobytes per second, and topology information.

ratio

A ratio is the parameter in a virtual server statement that assigns a weight to the virtual server for load balancing purposes.

Ratio mode

The Ratio load balancing mode is a static load balancing mode that distributes connections across an pool of virtual servers in proportion to the ratio weight assigned to each individual virtual server.

receiver 3-DNS

A receiver 3-DNS is a system, in a sync group, that receives metrics data that are broadcast from **big3d** agents, but does not initiate metrics collection. See also *principal 3-DNS*.

redundant system

A redundant system is a pair of systems that are configured for fail-over. In a redundant system, one system runs as the active unit and the other system runs as the standby unit. If the active unit fails, the standby unit takes over and manages resolution requests.

remote administrative IP address

A remote administrative IP address is an IP address from which a system allows shell connections, such as SSH, RSH, or Telnet.

resolver

The resolver is the client part of the Domain Name System. The resolver translates a program's request for host name information into a query to a name server, and translates the response into an answer to the program's request. See also *name server*.

resource record

resource record is a record in a DNS database that stores data associated with domain names. A resource record typically includes a domain name, a TTL, a record type, and data specific to that record type. See also *A record*, *CNAME record*, *NS record*.

reverse domains

A type of DNS resolution request that matches a given IP address to a domain name. The more common type of DNS resolution request starts with a given domain name and matches that to an IP address.

root name server

A root name server is a master DNS server that maintains a complete DNS database. There are approximately 13 root name servers in the world that manage the DNS database for the World Wide Web.

Round Robin mode

Round Robin mode is a static load balancing mode that bases connection distribution on a set server order. Round Robin mode sends a connection request to the next available server in the order.

Round Trip Time mode

Round Trip Time mode is a dynamic load balancing mode that bases connection distribution on which virtual server has the fastest measured round trip time between the data center server and the local DNS server.

RTT (round trip time)

RTT is the calculation of the time (in microseconds) that a local DNS server takes to respond to a ping issued by the **big3d** agent running on a data center server. The 3-DNS Controller takes RTT values into account when it uses dynamic load balancing modes.

secondary DNS

The secondary DNS is a name server that retrieves DNS data from the name server that is authoritative for the DNS zone.

Setup utility

The Setup utility is a utility that takes you through the initial system configuration process. The Setup utility runs automatically when you turn on a 3-DNS Controller for the first time.

site content

Site content is data (including text, images, audio, and video feeds) that is accessible to clients who connect to a given site. See also *dynamic site content*, *static site content*.

SNMP (Simple Network Management Protocol)

SNMP is the Internet standard protocol, defined in STD 15, RFC 1157, that was developed to manage nodes on an IP network.

sod (switch over daemon)

The **sod** daemon controls the fail-over process in a redundant system.

SSH

SSH is a protocol for secure remote login and other secure network services over a non-secure network.

standby unit

A standby unit is a system in a redundant system that is always prepared to become the active unit if the active unit fails.

static load balancing modes

Static load balancing modes base the distribution of name resolution requests to virtual servers on a pre-defined list of criteria and server and virtual server availability; they do not take current server performance or current connection load into account.

static site content

Static site content is a type of site content that is stored in HTML pages, and changes only when an administrator edits the HTML document itself.

subdomain

A subdomain is a sub-section of a higher level domain. For example, **.com** is a high level domain, and **F5.com** is a subdomain within the **.com** domain.

sub-statement

A sub-statement is a logical section within a statement that defines a particular element in the statement. A sub-statement begins with the sub-statement name followed by an open brace ({) and ends with a closed brace (}). Everything between those braces is part of the sub-statement. Sub-statements typically define a group of related variables, such as the calculation coefficients used in Quality of Service load balancing.

sync group

A sync group is a group of 3-DNS Controllers that share system configurations and path metrics for data center servers and virtual servers. Sync groups have one principal 3-DNS, and may contain one or more receiver systems. The receiver systems obtain their configuration information from the principal system. See also *principal 3-DNS*, *receiver 3-DNS*.

time tolerance value

The time tolerance value is the number of seconds that one 3-DNS Controller's clock is allowed to differ in comparison to another 3-DNS Controller's clock, without the two clocks being considered out of sync.

Topology mode

The Topology mode is a static load balancing mode that bases the distribution of name resolution requests on the weighted scores for topology records. Topology records are used by the Topology load balancing mode to redirect DNS queries to the closest virtual server, geographically, based on location information derived from the DNS query message.

topology record

A topology record specifies a score for a local DNS server location endpoint and a virtual server location endpoint.

topology score

The topology score is the weight assigned to a topology record when the 3-DNS Controller is filtering the topology records to find the best virtual server match for a DNS query.

topology statement

A topology statement is a collection of topology records.

traceroute

Traceroute is the utility that the hops factory uses to calculate the total number of network hops between a local DNS server and a specific data center.

TTL (Time to Live)

The TTL is the number of seconds for which a specific DNS record or metric is considered to be valid. When a TTL expires, the server usually must refresh the information before using it again.

unavailable

The **unavailable** is a status used for data center servers and virtual servers. When a data center server or virtual server is **unavailable**, the 3-DNS Controller does not use it for load balancing.

unknown

The **unknown** status is used for data center servers and virtual servers. When a data center server or virtual server is new to the 3-DNS Controller and does not yet have metrics information, the 3-DNS Controller marks its status as **unknown**. The 3-DNS Controller can use unknown servers for load balancing, but if the load balancing mode is dynamic, the 3-DNS Controller uses default metrics information for the unknown server until it receives live metrics data.

up

The **up** status is used for data center servers and virtual servers. When a data center server or virtual server is **up**, the data center server or virtual server is available to respond to name resolution requests.

virtual server

A virtual server is a specific combination of a virtual IP address and virtual port, and is associated with a content site that is managed by a BIG-IP, EDGE-FX Cache, or host server.

watchdog timer card

The watchdog timer card is a hardware device that monitors the 3-DNS Controller for hardware failure.

wide IP

A wide IP is a collection of one or more domain names that maps to one or more groups of virtual servers managed either by BIG-IP systems, EDGE-FX Caches, or by host servers. The 3-DNS Controller load balances name resolution requests across the virtual servers that are defined in the wide IP that is associated with the requested domain name.

WKS (well-known services)

Well-known services are protocols on ports 0 through 1023 that are widely used for certain types of data. Some examples of some well-known services (and their corresponding ports) are: HTTP (port 80), HTTPS (port 443), and FTP (port 20).

WKS record

A WKS record is a DNS resource record that describes the services usually provided by a particular protocol on a specific port.

zone

In DNS terms, a zone is a subset of DNS records for one or more domains.

zone file

In DNS terms, a zone file is a database set of domains with one or many domain names, designated mail servers, a list of other name servers that can answer resolution requests, and a set of zone attributes, which are contained in an SOA record.



Index

/etc/hosts file 4-1

3-DNS Maintenance menu

about 1-3

3-DNS modes

configuring 3-11

3dns_add script

about 10-1

and sync groups 10-1

running the script 10-4

verifying the configuration 10-4

A

A records 2-3

active-active configurations

and unit ID numbers 3-6

additional systems

configuring 10-1

admin user account 3-9

administrative access

IP addresses allowed 3-9

Administrator Kit, PDF versions 1-11

authentication server 1-10

auto configuration

overview 5-15

auto-configuration 1-9, 5-6

B

base network, planning 2-6

basic configuration

adding a 3-DNS Controller 5-5

adding a BIG-IP system 5-6

adding data centers 5-3

adding EDGE-FX systems 5-9

adding hosts 5-10

configuring global variables 5-17

creating a sync group 5-13

setting up 5-2

big3d agent

about 1-7

broadcasting 2-1

configuring 2-9

sample configuration 2-1

BIG-IP Cache Controller, selecting 3-5

BIG-IP Fire Guard, selecting 3-5

BIG-IP LB, selecting 3-5

BIG-IP system

compare to 3-DNS Controller 1-8

defining 5-6

bridge mode

about 3-11

browsers, supported versions 1-3

C

CDN

configuration example 7-2

configuring 7-5

delegating DNS queries 7-2

described 7-1

managing with 3-DNS 7-1

using pool type CDN 7-1

using topology load balancing 7-1

CDN configuration

adding 3-DNS Controllers 7-5

adding a topology statement 7-8

adding data centers 7-5

adding pool type CDN 7-7

adding servers 7-6

adding wide IPs and pools 7-6

monitoring 7-10

using a last resort pool 7-9

CDN providers

described 7-1

resolving DNS queries 7-3

CDN switching 7-1

centralized authentication 1-10

certificates

configuration information 3-8

command line utility. See 3-DNS Maintenance menu

command syntax, conventions 1-5

configuration

adding to 5-5

configuration planning 2-6

configuration tasks

using a remote workstation 2-6

configuration tools, choosing 1-2

Configuration utility

about 1-2

and supported browser versions 1-3

configurations, verifying 10-4

configuring FTP access 3-16

configuring rshd 3-13

connections, administrative 3-10

content delivery network. See CDN

content servers

default route 3-7

D

data center 5-3

data center servers

in the network configuration 2-6

data centers

about 2-6

adding a 3-DNS Controller 10-1

configuring 5-3

default configuration

user name 3-2

- default IP addresses
 - alternate address 3-2
 - and IP alias 3-3
 - overview 3-2
 - preferred address 3-2
- default root password 3-2
- default route configuration 3-8
- discovery 5-16
 - modifying 5-15
 - settings for 5-15
- Discovery setting 1-9
- DNS
 - master servers 2-3
 - root servers 2-4
- DNS queries
 - delegating to CDN providers 7-2
- documentation 1-11
- domain names, maximum supported 1-6
- duplex mode 4-3
- Dynamic Ratio
 - about 8-6
 - configuring 8-6
 - using with QOS mode 8-6

E

- EDGE-FX system
 - configuring 5-9
- EDGE-FX systems
 - defining 5-9
- encryption
 - and crypto systems 5-17
 - and global variables 5-17
 - enabling 5-17

F

- fail-over
 - hardware-based 1-8
 - network-based 1-8
- fail-over IP addresses, setting 3-6
- features of 3-DNS 1-5
- firewalls 1-10
- FQDNs
 - enabling web access 3-8

G

- geographic redirection 7-1
- Global Availability mode
 - about 9-1
 - configuring 9-3
 - configuring standby data centers 9-5
 - load balancing among pools 9-3
- global variables
 - configuring 5-17
 - enabling encryption 5-17

- globally-distributed network
 - adding 3-DNS Controllers 6-3
 - adding BIG-IP systems 6-4
 - adding data centers 6-3
 - configuring 6-2
 - using Topology load balancing 6-2
- GLOBAL-SITE Controller
 - See EDGE-FX system

H

- hardware-based fail-over 1-8
- help, online 1-11
- host names
 - BIG-IP host name 3-6
 - changing 3-9
 - primary IP address 3-8
- host servers
 - defining 5-10
- host SNMP settings
 - configuring 5-12
- hosts
 - and probes 5-10, 5-12
 - and supported SNMP agents 5-12
 - configuring 5-10
 - viewing statistics 5-13
- hosts file, adding host names 4-1
- httpd.conf file
 - and Setup utility 3-9

I

- iControl 3-15
- interface access methods 4-7
- interface media settings 3-7
- interface naming convention 4-2
- interfaces
 - and multiple VLANs 4-7
 - naming convention 4-2
- internal VLANs 3-3
- Internet protocols 1-6
- IP addresses
 - and NameSurfer 1-2
 - changing 3-9
 - configuring default route 3-8
 - configuring fail-over 3-6
 - for default configuration 3-2
- IP alias, for default IP address 3-3
- iQuery protocol
 - about 1-6

K

- keyboard type, setting 3-5

L

- last resort pool
 - using in a CDN configuration 7-9
- LDAP 1-10
- LED indicators 3-7
- limits settings
 - modifying thresholds 6-7
- load balancing modes
 - Global Availability 9-3
 - Quality of Service 8-1
 - Topology 6-2
- load balancing, using pools 2-4

M

- MAC addresses 4-11
 - setting MAC masquerade 4-2
- MAC masquerade 4-11
- media access control. See MAC addresses
- media options 1-7
- media type
 - setting 4-3
 - setting the duplex mode 4-3
- metrics
 - and hosts 5-12
 - collecting from hosts 5-12
- Microsoft Internet Explorer 1-3
- multiple links 1-10

N

- name resolution 2-3, 2-4
- NameSurfer
 - about 1-2
 - configuring 3-13
 - managing DNS zone files 2-10
 - maximum supported IP addresses 1-2
- naming conventions
 - for interfaces 4-1
- Netscape Navigator 1-3
- network adapters 3-7
- network address translations 1-10
- network configuration
 - configuring rsh 2-9
 - configuring ssh 2-9
- network management tools 1-6
- Network Time Protocol (NTP) 3-10
- network-based fail-over 1-8
- node mode
 - about 3-11

O

- online help 1-11
- openssl.conf file 3-9

P

- P95 Billing Estimate 1-10
- packets
 - access to VLANs 4-7
- password
 - creating for system and user accounts 1-9
- passwords 3-2
 - default configuration 3-2
- PDF versions, Administrator Kit 1-11
- pools 2-4
- portal 3-15
- principal 3-DNS
 - about 2-2, 5-13
 - adding a system to sync group 10-3
 - planning sync groups 2-7
- probers
 - and hosts 5-10, 5-12
- product selection 3-5
- production rules 2-12

Q

- QOS coefficients
 - about 8-2
 - and wide IPs 8-4
 - configuring 8-3
 - considerations 8-2
- QOS equation
 - modifying 8-3
 - syntax 8-4
- Quality of Service mode
 - about 8-1
 - and default settings 8-1
 - understanding QOS coefficients 8-2
 - using Dynamic Ratio 8-6

R

- RADIUS 1-10
- receiver 3-DNS
 - about 5-13
 - planning sync groups 2-7
- redundant systems 1-8
 - active-active configurations 3-6
 - choosing fail-over IP addresses 3-6
 - floating self IP alias 3-7
 - sharing MAC addresses 4-12
 - unit ID numbers, setting 3-6
- release notes 1-11
- remote shell. See RSH
- resource thresholds
 - setting limits 6-7
- root password
 - setting 3-5
- router
 - defining 5-8

routers, host names 4-1

RSH

 configuring 3-16

rsh utilities 2-9

S

sample 3-DNS configuration 2-1

sample configuration

 big3d agent communications 2-1

scalability 1-6

security features 1-6

self IP address, about 4-12

self IP addresses

 and translations 1-10

 for target devices 3-7

server performance

 monitoring 6-8

server types 5-5

servers

 defining 2-7

 defining a 3-DNS Controller 5-5

 defining a BIG-IP system 5-6

 defining additional 3-DNS Controllers 10-1

 defining in the configuration 5-5

 See also data center servers

setup command 3-2

Setup utility 1-2

 configuring 3-DNS mode 3-11

 configuring NameSurfer 3-13

 default IP address access 3-3

 default password 3-2

 NTP support 3-10

 purpose of 4-1

 rerunning from a web browser 3-4

 rerunning from the command line 3-5

 running from a browser 3-3

 running from an ssh client 3-4

 running from the command line 3-4

 running from the console 3-2

 system settings defined 3-1

single physical location 5-3

SMTP 1-6

SNMP 1-6

 and host prober 5-12

 host prober 5-10

SNMP agents

 and supported hosts 5-12

SNMP host probing 5-12

SNMP MIB 1-2

SNMP prober 5-12

SSH

 MindTerm SSH console 1-6

ssh utilities 2-9

SSL 1-6

statistics screens 1-10

stylistic conventions 1-4

sync group

 about 1-7, 2-8

 and 3dns_add script 10-1

 and time tolerance variable 2-8

 and zone files 2-11

 broadcasting configurations 2-6

 configuring 5-13

 defined 2-7

 planning 2-6

 planning configurations 2-7

 sample configuration 2-2

sync groups

 and additional systems 10-1

 configuring 5-13

 defined 5-13

synchronization 1-9

synchronized files

 and time tolerance variable 2-8

 and zone files 2-11

system accounts 1-9

system resources

 about 6-7

 setting limits 6-7

T

tagged interfaces

 defined 4-7

tags

 embedding in packet headers 4-7

technical support 1-11

time tolerance value

 setting 5-14

time tolerance variable 5-14

 about 2-8

 and sync groups 2-8

time zone, configuring 3-10

Topology load balancing

 about 2-12

 using in a CDN 7-8

 using in a global network 6-2

topology records

 configuring 6-6

topology statement

 configuring topology records 6-6

 using in a CDN 7-8

traffic

 restricting through tagged interfaces 4-7

 restricting through untagged interfaces 4-7

U

unit ID numbers 3-6

untagged interfaces

 defined 4-7

User Access screen 1-9

- user accounts 1-9
- user authorization 1-10
- user authorization roles 1-10
- utilities
 - 3-DNS Maintenance menu 1-3
 - Configuration 1-2
 - Setup 1-2

V

- virtual servers
 - and host names 4-1
 - availability settings 6-7
 - defining 2-7
- VLAN access methods 4-7
- VLAN groups 4-9
- VLAN IDs 4-7
- vlangroup command 4-9

VLANs

- configuring in Setup utility 3-7
- default IP address 3-3
- interfaces, assigning 3-8
- managing 4-5
- self IP address 3-7

W

- web server access
 - adding user accounts 3-9
 - changing passwords 3-9
 - configuring 3-8
- wide IPs
 - and DNS zone files 2-10
 - and QOS coefficients 8-4
- wide-area traffic manager (WATM) 7-4

Z

- zone file management
 - using NameSurfer 1-2
- zone files
 - configuring 3-13
 - synchronizing 3-DNS Controllers 2-11